

# 4/3, 4/2 and 3/2 directional valve with fluidic actuation

**RE 22282/04.10**  
Replaces: 08.08

1/12

## Type WP, WH

Size 6  
Component series 6X (WP), 5X (WH)  
Maximum operating pressure 315 bar [4569 psi]  
Maximum flow 60 l/min [15.8 US gpm]



H6875

## Table of contents

Content	Page
Features	1
Ordering code	2
Standard types	2
Symbols	3
Types of actuation	4
Function, section	5
Technical data	6
Characteristic curves	7
Performance limits	8, 9
Unit dimensions	10 to 12

## Features

- Direct operated directional spool valve
- Types of actuation:
  - Pneumatic (WP, WPZ)
  - Hydraulic (WH, WHZ)
- Porting pattern according to DIN 24340 form A (**without** locating hole)
- Porting pattern according to ISO 4401-03-02-0-05 and NFPA T3.5.1 R2-2002 D03 (**with** locating hole)
- Subplates according to data sheet 45052 (separate order)
- Inductive positions with and proximity sensor (contactless), see data sheet 24830

Information on available spare parts:  
[www.boschrexroth.com/spc](http://www.boschrexroth.com/spc)

## Ordering code

	W			6	/	J	/				*
3 main ports = 3											Further details in the plain text
4 main ports = 4											
Directional valve = W											no code = without locating hole
<b>Type of actuation</b>											
Pneumatic = P											/60 <sup>5)</sup> = with locating hole
Hydraulic = H											/62 = with locating hole and locating pin ISO 8752-3x8-St
Connections radial = no code											<b>Clamping length</b> no code = 42 mm (standard) Z = 22 mm
Connections axial = Z <sup>1)</sup>											
Size 6 = 6											<b>Seal material</b> no code = NBR seals V = FKM seals (other seals upon request) Attention! Observe compatibility of seals with hydraulic fluid used!
Spool symbol e.g. C, E, EA, EB, etc. <sup>2)</sup>											
<b>Type WP</b> Component series 60 to 69 (60 to 69: unchanged installation and connection dimensions)											no code = without throttle insert <b>B08<sup>6)</sup></b> = Throttle Ø 0.8 mm [0.0315 inch] <b>B08<sup>6)</sup></b> = Throttle Ø 1.0 mm [0.0394 inch] <b>B12<sup>6)</sup></b> = Throttle Ø 1.2 mm [0.0472 inch]
<b>Type WH</b> Component series 50 to 59 (50 to 59: unchanged installation and connection dimensions)											
with spring return = no code											<b>Spool position monitoring<sup>7)</sup></b> no code = without position switch <b>QMAG24</b> = Monitored spool position "a" <b>QMBG24</b> = Monitored spool position "b" <b>QM0G24</b> = Monitored rest position For further details see data sheet 24830
without spring return = O											
without spring return with detent = OF											
Improved corrosion protection <sup>3)</sup> = J											
without manual override = no code											
with manual override = N <sup>3)</sup>											

**Standard types and standard units are contained in the EPS (standard price list).**

	Spool positions			
	2	3	Type WP, Type WPZ	Type WP, Type WHZ
no code	✓	✓	✓	✓
O	✓		✓	✓
OF	✓		✓	✓

• = Available

1) Not for model "N"

2) Symbols and examples, see pages 3 and 4

3) The external metal parts are galvanized, treated with anti-corrosion agent or manufactured from stainless steel. This model is also suitable for on-deck applications.

4) Only for pneumatic actuation "P"

6) Use if volume flow > performance limit of the valve, effective in channel P

5) Locating pin ISO 8752-3x8-St, material no. **R900005694**, separate order

7) Not for model "J"

### Spool symbols

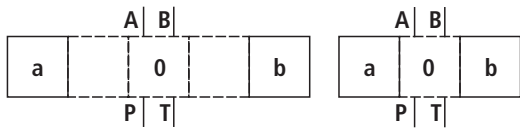
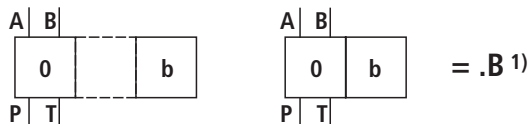
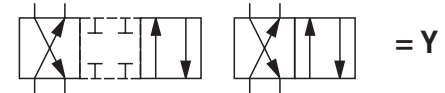
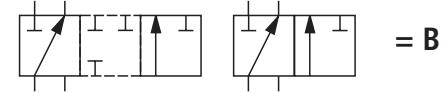
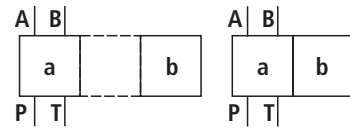
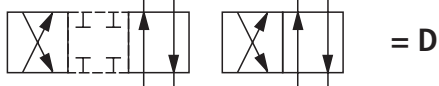
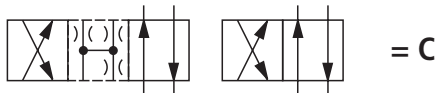
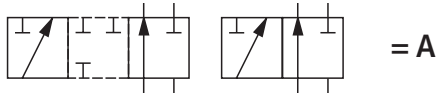
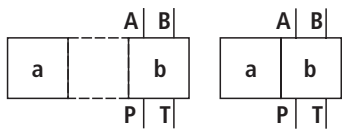

**1) Example:**

- Spool symbol E with spool position "a" → ordering code **..EA..**
- Spool symbol E with spool position "b" → ordering code **..EB..**

**2) Symbol E1-: P → A/B pre-opening**

**Attention!**

Caution in conjunction with single-rod cylinders due to pressure intensification!

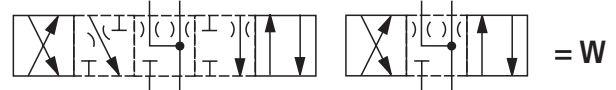
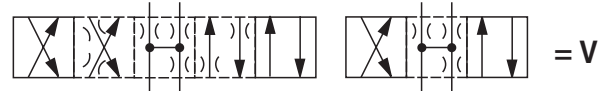
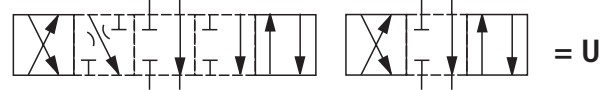
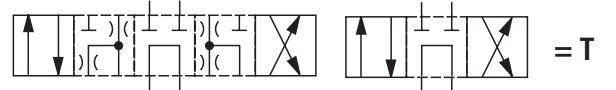
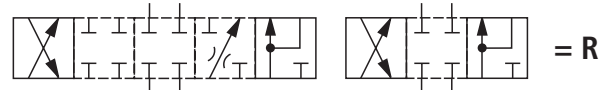
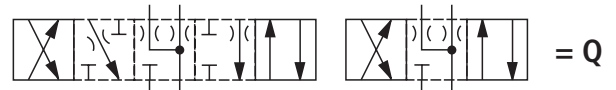
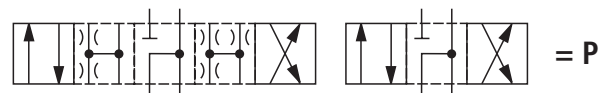
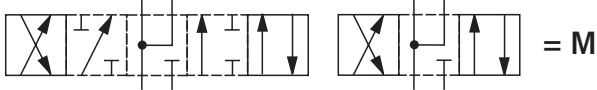
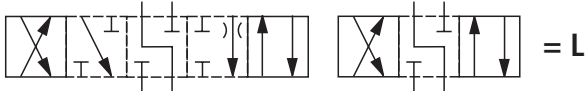
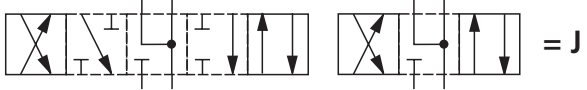
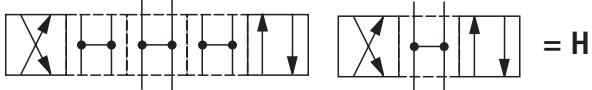
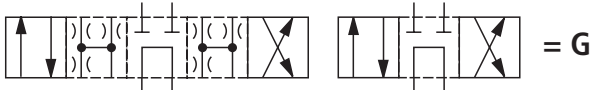
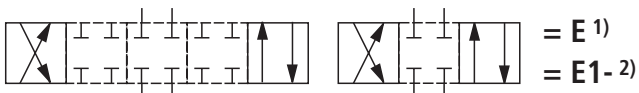

## Types of actuation

Spool symbol	Codification		Type of actuation	
	Actuation side	Spool return	P (pneumatic)	H (hydraulic)
A, C, D				
		../O..		
		../OF..		
B, Y				
E, F G, H J, L M, P Q, R T, U V, W	"a" <sup>1)</sup> = .A			
	"b" <sup>1)</sup> = .B			

<sup>1)</sup> See symbols page 3.

## Function, section

### General

Valves of type WP and WH are directional spool valves with fluid logics actuation. They control the start, stop and direction of a flow.

The directional valves basically consist of housing (1), one or two actuation elements (2) (hydraulic, pneumatic actuation cylinder), control piston (3), and one or two return springs (4). The connections for control are arranged in a radial (model "WP", "WH") (5) or axial (model "WPZ", "WHZ") (6) way.

In the de-energized condition, control piston (3) is held in the central position or in the initial position by the return springs (4) (except for impulse spool).

The control spool (3) is moved to the required spool position by means of the actuation elements.

### Throttle insert

The use of a throttle insert is required when due to prevailing operating conditions, flows can occur during the switching processes, which exceed the performance limit of the valve.

It is inserted in channel P of the directional valve.

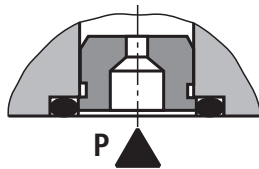

### Without spring return with detent, model ..OF/..

Directional valves with hydraulic or pneumatic actuation are also available as 2-spool position valve with detent (7). If using actuation elements with detent, every spool position can be locked.

### Without spring return, model ..O/..

If using actuation elements without return springs and without detent, a defined spool position is not given in the de-energized condition.

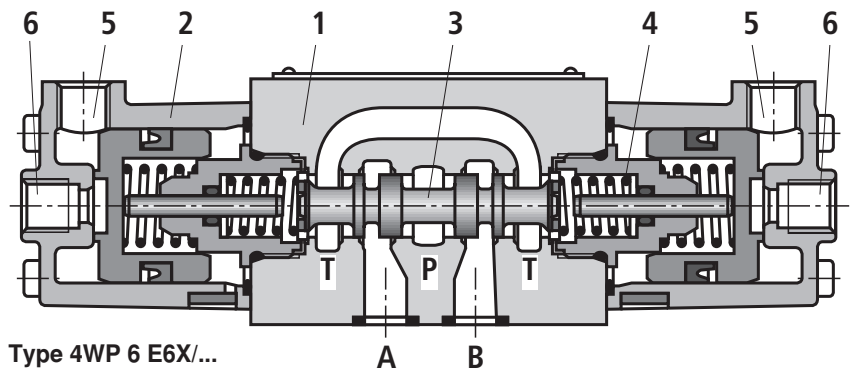

Type 4WP 6 E6X/...

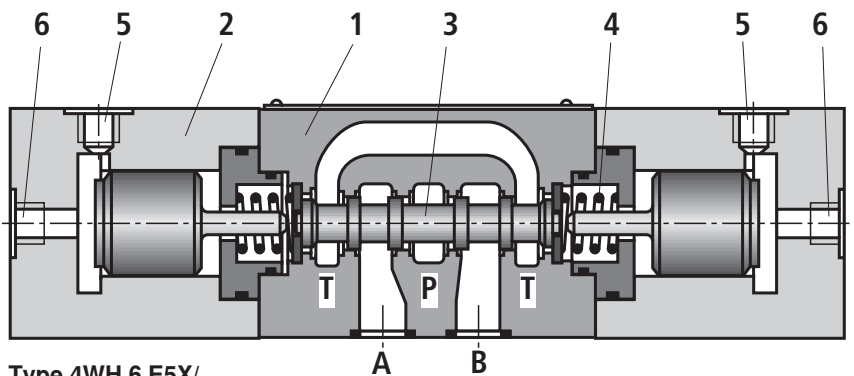

Type 4WH 6 E5X/...

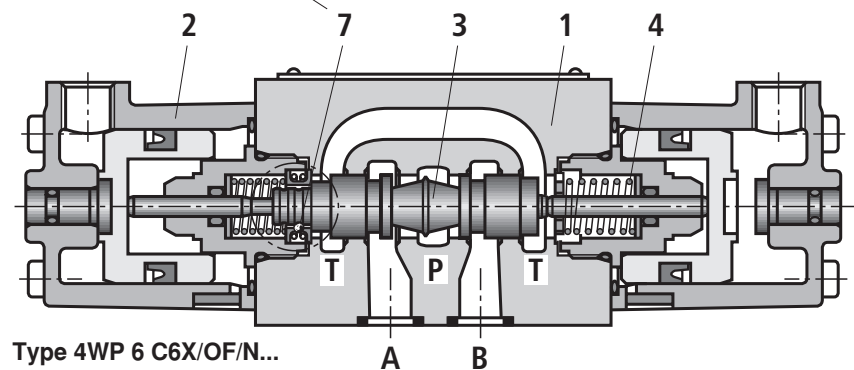
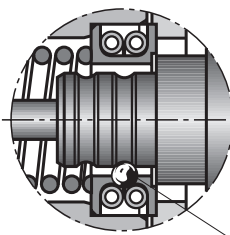

Type 4WP 6 C6X/OF/N...

**Technical Data** (For applications outside these parameters, please consult us!)**general**

Version			"WP"	"WH"	"WHZ"
Weight	– Valve with one actuation cylinder	kg [lbs]	approx. 1.8 [3.97]	approx. 2.0 [4.41]	approx. 2.2 [4.85]
	– Valve with two actuation cylinders	kg [lbs]	approx. 2.0 [4.41]	approx. 2.2 [4.85]	approx. 2.4 [5.29]
Installation position			Any <sup>1)</sup>		
Ambient temperature range		°C [°F]	–30 to +80 [–22 to +176] (NBR seals) –20 to +80 [–4 to +176] (FKM seals)		

**hydraulic**

Maximum operating pressure	– Port A, B, P	bar [psi]	315 [4569]	
	– Port T	bar [psi]	160 [2320] With symbols A and B, port T must be used as leakage port if the operating pressure exceeds the tank pressure.	
Maximum flow		l/min [US gpm]	60 [15.8]	
Flow cross-section (Spool position 0)	– for spool symbol Q		6 % of nominal cross-section	
	– for spool symbol W		3 % of nominal cross-section	
Minimum pilot pressure		bar [psi]	4 (see characteristic curve page 7)	6 to 10 > tank pressure <sup>2)</sup>
Maximum pilot pressure		bar [psi]	10 [145]	200 [2900]
Pilot volume		cm <sup>3</sup> [in <sup>3</sup> ]	4,24 [0.26]	1,23 [0.075]
Hydraulic fluid			Mineral oil (HL, HLP) according to DIN 51524 <sup>3)</sup> ; fast biodegradable hydraulic fluids according to VDMA 24568 (see also RE 90221); HETG (rape seed oil) <sup>3)</sup> ; HEPG (polyglycols) <sup>4)</sup> ; HEES (synthetic esters) <sup>4)</sup> ; other hydraulic fluids upon request	
Hydraulic fluid temperature range		°C [°F]	–30 to +80 [–22 to +176] (NBR seals) –20 to +80 [–4 to +176] (FKM seals)	
Viscosity range		mm <sup>2</sup> /s [SUS]	2.8 to 500 [35 to 2320]	
Maximum permitted degree of contamination of the hydraulic fluid - cleanliness class according to ISO 4406 (c)			Class 20/18/15 <sup>5)</sup>	
Maximum switching frequency		1/h	7200	

<sup>1)</sup> For models ..O.. (A, C, and D): Horizontal

<sup>2)</sup> Performance limit depending on the minimum pilot pressure, see page 9

<sup>3)</sup> Suitable for NBR **and** FKM seals

<sup>4)</sup> Suitable **only** for FKM seals

<sup>5)</sup> The cleanliness classes specified for the components must be adhered to in hydraulic systems. Effective filtration prevents faults and at the same time increases the service life of the components.

For the selection of filters, see data sheets 50070, 50076, 50081, 50086, 50087 and 50088.

**Characteristic curves** (measured with HLP46,  $\vartheta_{oil} = 40\text{ °C} \pm 5\text{ °C}$  [ $104\text{ °F} \pm 9\text{ °F}$ ])

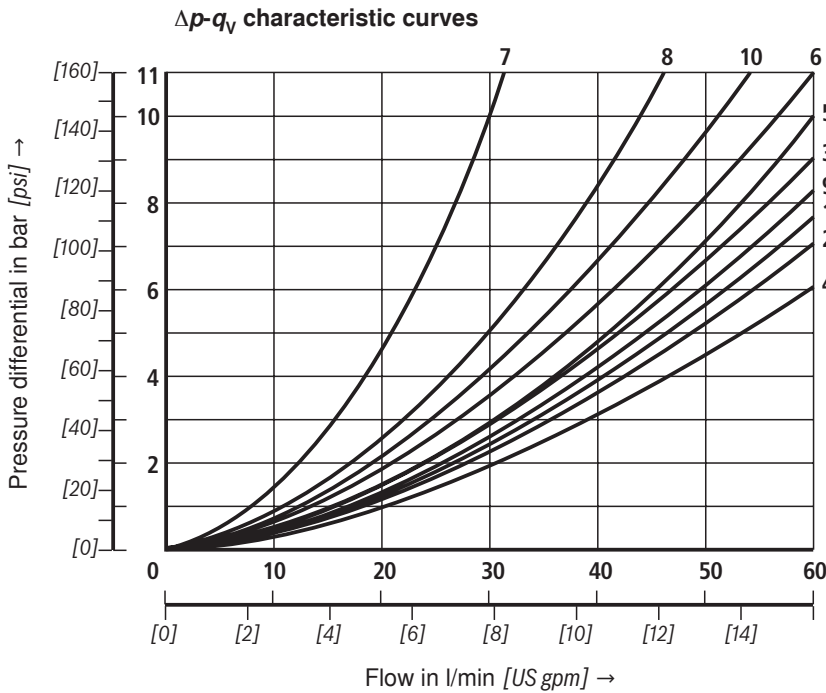

Spool symbol	Flow direction			
	P-A	P-B	A-T	B-T
A	3	3	-	-
B	3	3	-	-
C	1	1	3	1
D	5	5	3	3
E	3	3	1	1
F	1	3	1	1
G	6	6	9	9
H	2	4	2	2
J	1	1	2	1
L	3	3	4	9
M	2	4	3	3
P	3	1	1	1
Q	1	1	2	1
R	5	5	4	-
T	10	10	9	9
U	3	3	9	4
V	1	2	1	1
W	1	1	2	2
Y	5	5	3	3

**Further characteristic curves:**

- 7 Spool symbol "R" in spool position "b" (B → A)
- 8 Spool symbol "G" and "T" in central position (P → T)
- 9 Spool symbol "H" in central position (P → T)

**Minimum pilot pressure depending on tank pressure**

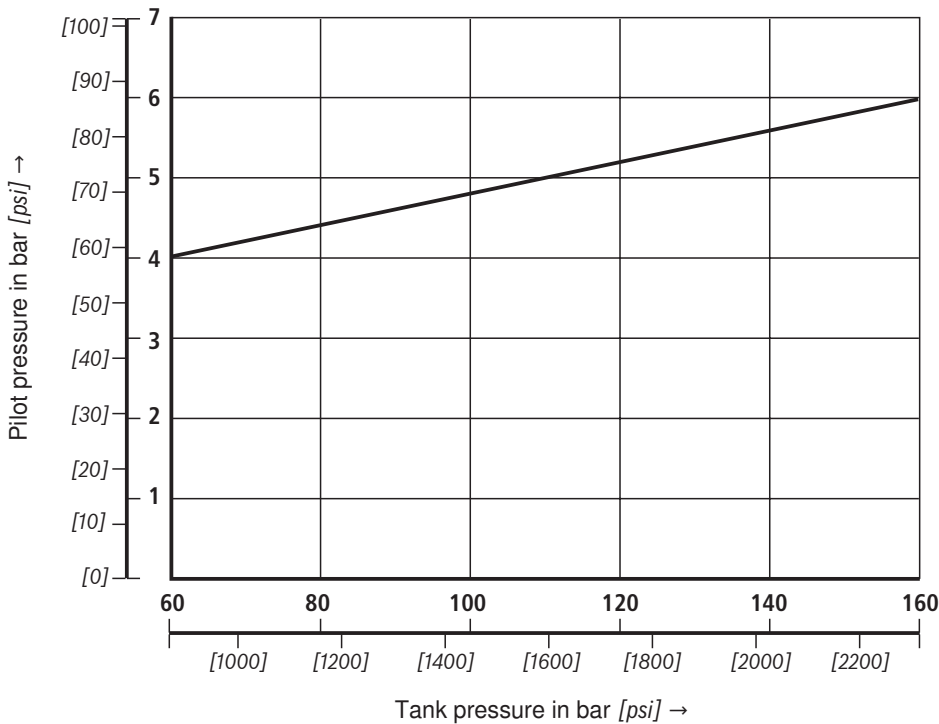

In case of a higher tank pressure, the minimum pilot pressure has to be increased according to this diagram.

## Performance limits: Type WP, WPZ (measured with HLP46, $\vartheta_{oil} = 40 \text{ }^\circ\text{C} \pm 5 \text{ }^\circ\text{C} [104 \text{ }^\circ\text{F} \pm 9 \text{ }^\circ\text{F}]$ )

### Note!

Because of the adhesive effect, the switching function of the valves depends on the filtration. In order to achieve the specified admissible flow values, we recommend full flow filtration with  $25 \mu\text{m}$ . The flow forces acting within the valves also affect the flow performance.

With 4 way valves the specified flow data thus apply to normal operation with 2 volume flow directions (e.g. from P to A and at the same time return flow from B to T) (see table).

If only one flow direction is available, in critical cases, the admissible flow can be significantly smaller (e.g. when using a 4 way valve as 3 way valve, due to blocked connection A or B).

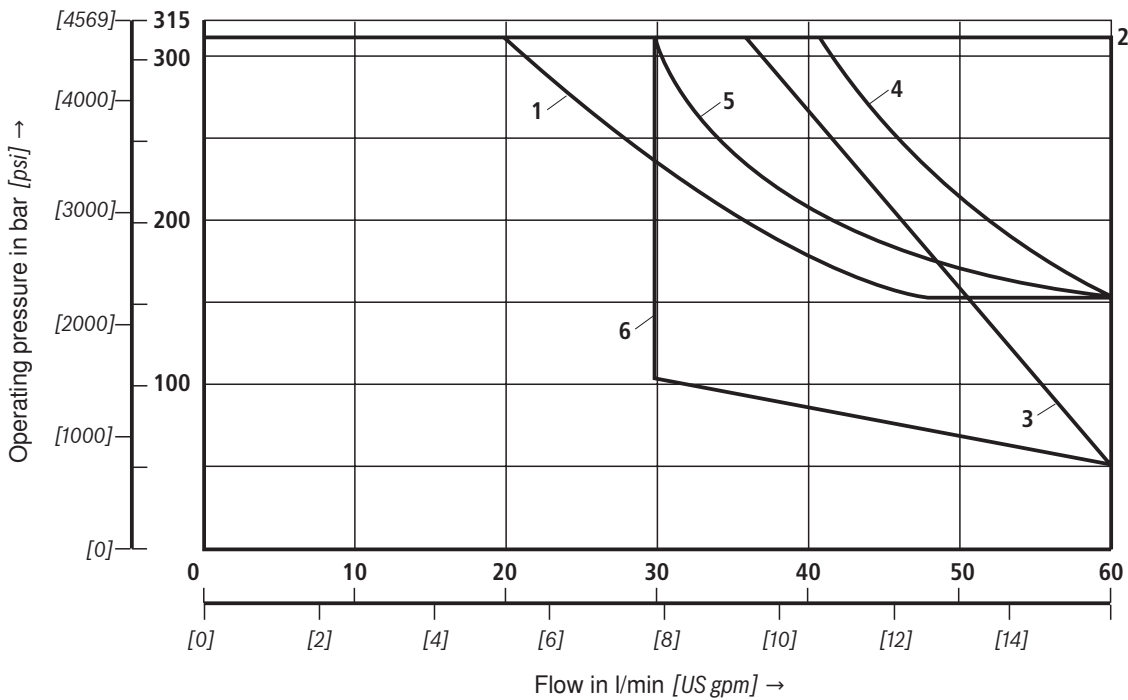

Characteristic curve	Spool symbol
1	A, B
2	A/O, C, C/O, D, D/O, E, E1-, G, H, J, L, M, Q, U, W, and Y
3	F, P
4	R
5	T
6	V



**Performance limits: Type WH, WHZ (measured with HLP46,  $\vartheta_{oil} = 40 \text{ }^\circ\text{C} \pm 5 \text{ }^\circ\text{C}$  [104 °F ± 9 °F])**

See note on page 8!

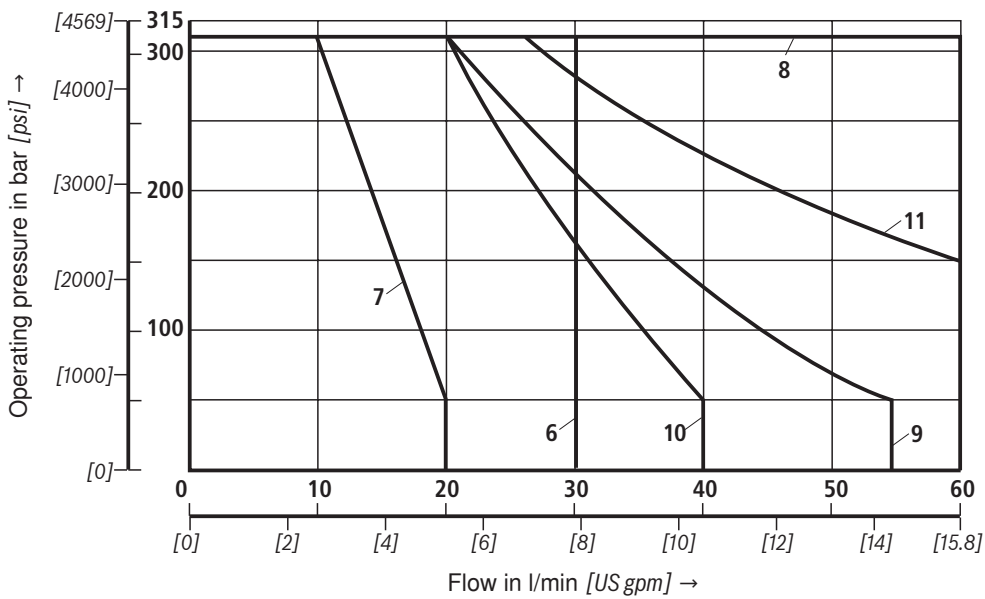
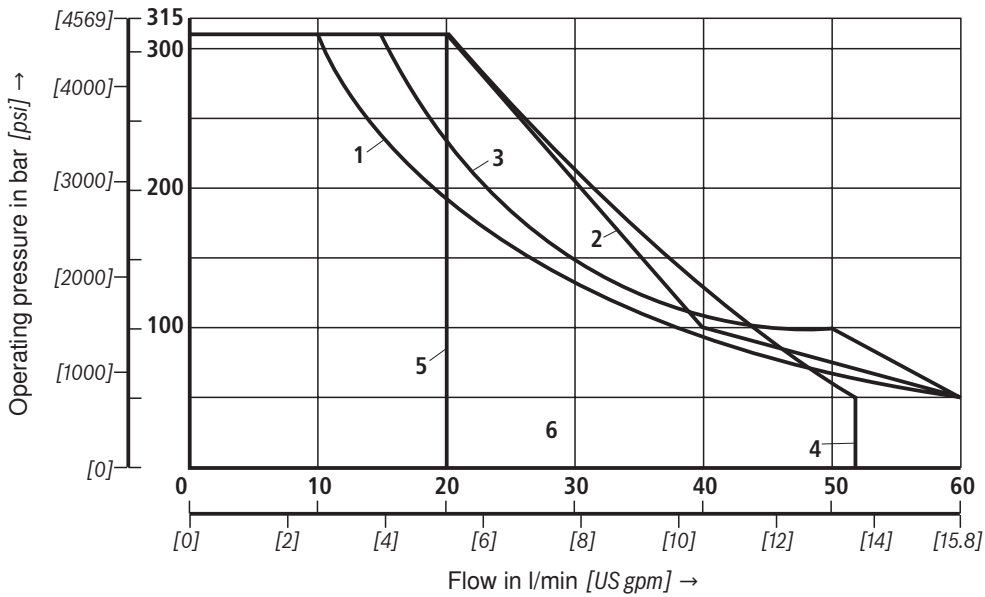

Pilot pressure 6 bar > tank pressure		
Spring return	Characteristic curve	Spool symbol
"no code" (with spring return)	1	A, B
	2	C, D, Y
	3	E, J, L, U, M, Q, V, W, E1-
	4	F, P
	5	T
	6	G, H
	7	R
../O..	8	A, C, D
../OF..		

Pilot pressure 10 bar > tank pressure		
Spring return	Characteristic curve	Spool symbol
"no code" (with spring return)	1	A, B
	8	C, D, Y, E, G, H, J, L, U, M, Q, V, W, E1-
	9	F, P
	10	R
	11	T
../O..	8	A, C, D
../OF..		

**Unit dimensions: Type WP, WPZ (dimensions in mm [inch])**

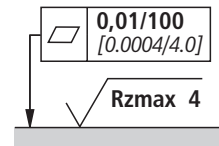
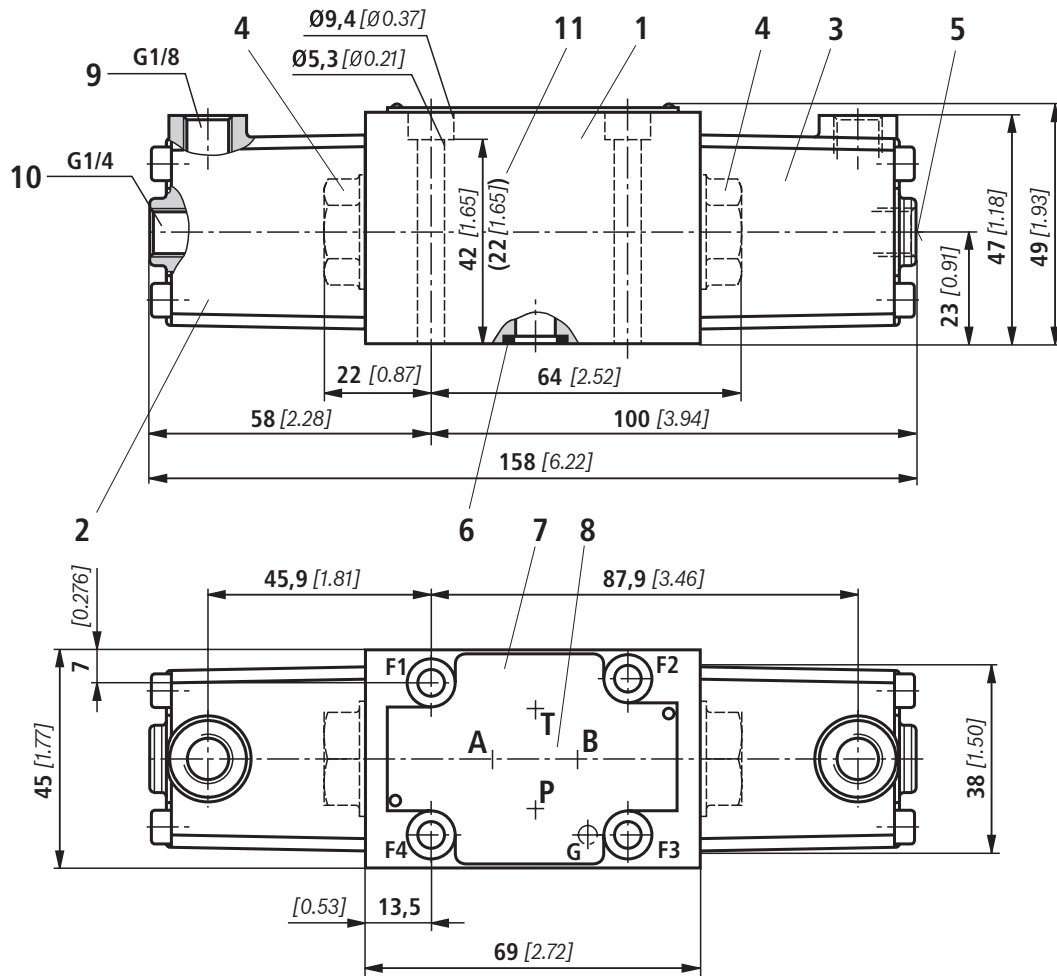

Required surface quality of the valve mounting face

- 1 Valve with 2 spool positions and 2 actuation cylinders  
Valve with 3 spool positions and 2 actuation cylinders
- 2 Actuation cylinder "a"
- 3 Actuation cylinder "b"
- 4 Plug screw for valve with 1 actuation cylinder (2 switching positions)
- 5 Manual override, optional (only with model "WP")
- 6 Identical seal rings for ports A, B, P, T
- 7 Name plate
- 8 Porting pattern according to DIN 24340 form A (**without** locating hole), or ISO 4401-03-02-0-05 and NFPA T3.5.1 R2-2002 D03 (**with** locating hole for locating pin ISO 8752-3x8-St Material no. **R900005694**, separate order)
- 9 Connection with model "WP"
- 10 Connection with model "WPZ"
- 11 Alternative clamping length ( ): 22 mm

**Subplates and valve mounting screws** see page 12.

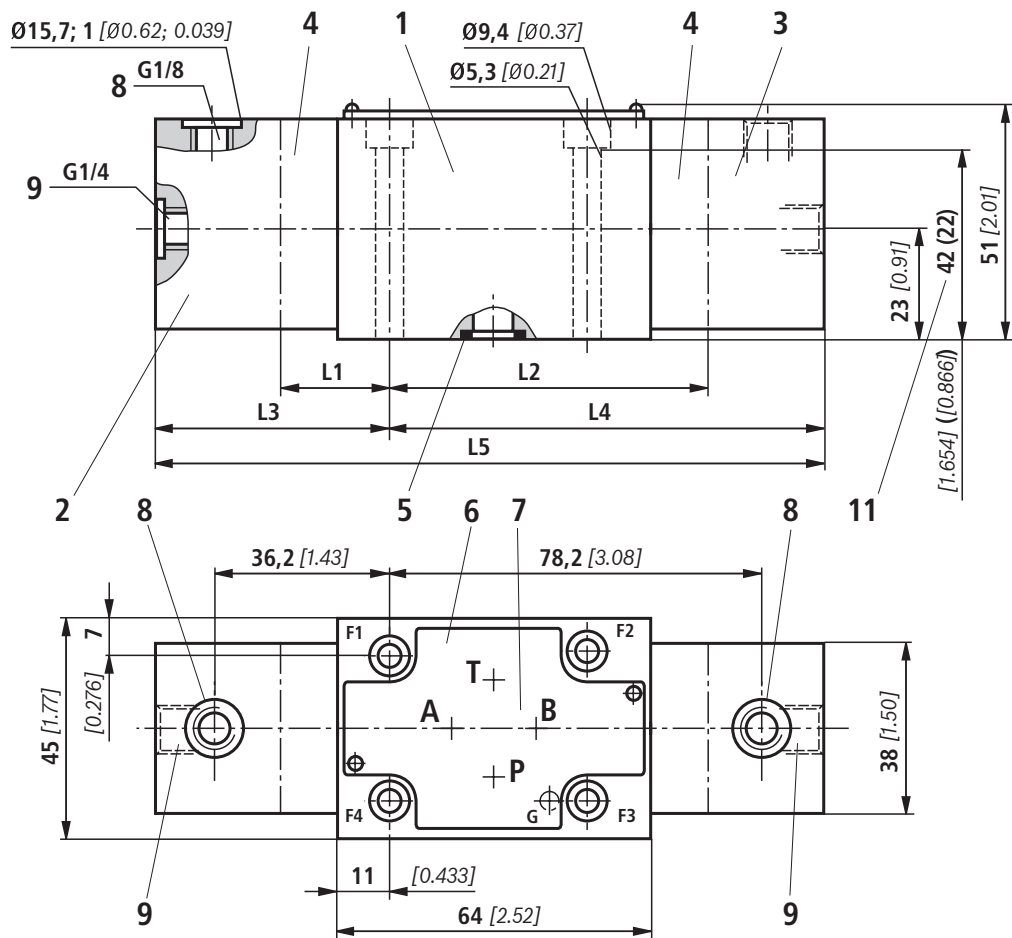
**Unit dimensions: Type WH, WHZ (dimensions in mm [inch])**

Type	L1	L2	L3	L4	L5
WH	22,5 [0.89]	64,5 [2.54]	48 [1.89]	90 [3.54]	138 [5.45]
WHZ	21,5 [0.85]	63 [2.48]	55 [2.16]	96,5 [3.80]	152 [5.98]

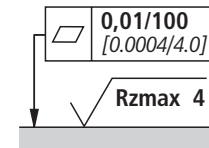

Required surface quality of the valve mounting face

- 1 Valve with 2 spool positions and 2 actuation cylinders  
Valve with 3 spool positions and 2 actuation cylinders
- 2 Actuation cylinder "a"
- 3 Actuation cylinder "b"
- 4 Cover for valve with 1 actuation cylinder  
(2 switching positions)
- 5 Identical seal rings for ports A, B, P, T
- 6 Name plate
- 7 Porting pattern according to DIN 24340 form A  
(**without** locating hole), or ISO 4401-03-02-0-05 and  
NFPA T3.5.1 R2-2002 D03 (**with** locating hole for lo-  
cating pin ISO 8752-3x8-St  
Material no. **R900005694**, separate order)
- 8 Connection with model "WH"
- 9 Connection with model "WHZ"
- 11 Alternative clamping length ( ): 22 mm

**Subplates and valve mounting screws** see page 12.

## Unit dimensions

**Subplates** according to data sheet 45052  
(separate order)

(without locating hole)	G 341/01 (G1/4)
	G 342/01 (G3/8)
	G 502/01 (G1/2)
(with locating hole)	G 341/60 (G1/4)
	G 342/60 (G3/8)
	G 502/60 (G1/2)
	G 341/12 (SAE-6) <sup>1)</sup>
	G 342/12 (SAE-8) <sup>1)</sup>
	G 502/12 (SAE-10) <sup>1)</sup>

<sup>1)</sup> On request

**Valve mounting screws** (separate order)

– Clamping length 42 mm:

**4 cylinder bolts, metric**

**ISO 4762 - M5 x 50 - 10.9-fIZn-240h-L**

(friction coefficient  $\mu_{\text{total}} = 0.09$  to  $0.14$ );

Tightening torque  $M_A = 7 \text{ Nm}$  [ $5.2 \text{ ft-lbs}$ ]  $\pm 10 \%$ ;

Material no. **R913000064**

or

**4 cylinder bolts**

**ISO 4762 - M5 x 50 - 10.9** (own procurement)

(friction coefficient  $\mu_{\text{total}} = 0.12$  to  $0.17$ );

Tightening torque  $M_A = 8.1 \text{ Nm}$  [ $6 \text{ ft-lbs}$ ]  $\pm 10 \%$

**4 hexagon socket head cap screw UNC**

**10-24 UNC x 2" ASTM-A574**

(friction coefficient  $\mu_{\text{total}} = 0.19$  to  $0.24$ );

Tightening torque  $M_A = 11 \text{ Nm}$  [ $8.2 \text{ ft-lbs}$ ]  $\pm 15 \%$ ,

(friction coefficient  $\mu_{\text{total}} = 0.12$  to  $0.17$ );

Tightening torque  $M_A = 8 \text{ Nm}$  [ $5.9 \text{ ft-lbs}$ ]  $\pm 10 \%$ ;

Material no. **R978800693**

– Clamping length 22 mm:

**4 cylinder bolts, metric**

**ISO 4762 - M5 x 30 - 10.9-fIZn-240h-L**

(friction coefficient  $\mu_{\text{total}} = 0.09$  to  $0.14$ );

Tightening torque  $M_A = 7 \text{ Nm}$  [ $5.2 \text{ ft-lbs}$ ]  $\pm 10 \%$ ,

Material no. **R913000316**

or

**4 cylinder bolts**

**ISO 4762 - M5 x 30 - 10.9** (own procurement)

(friction coefficient  $\mu_{\text{total}} = 0.12$  to  $0.17$ );

Tightening torque  $M_A = 8.1 \text{ Nm}$  [ $6 \text{ ft-lbs}$ ]  $\pm 10 \%$

**4 cylinder bolts UNC**

**10-24 UNC x 1 1/4"**

(friction coefficient  $\mu_{\text{total}} = 0.19$  to  $0.24$ );

Tightening torque  $M_A = 11 \text{ Nm}$  [ $8.2 \text{ ft-lbs}$ ]  $\pm 15 \%$ ,

(friction coefficient  $\mu_{\text{total}} = 0.12$  to  $0.17$ );

Tightening torque  $M_A = 8 \text{ Nm}$  [ $5.9 \text{ ft-lbs}$ ]  $\pm 10 \%$ ;

Material no. **R978802879**