



# Decanter Centrifuge Data Sheet

## Decanter Specification, Type ALDEC 30

Machine No.: 5124052/53

Date of issue: 2012-06-21

Specification: 882012912-1

Process liquid: Min. 0°C (32°F) - max. 60°C (140°F)

Max. density of compact wet cake at max. bowl speed: 3.0 kg/dm<sup>3</sup>

### Bowl

Maximum main speed:	4400 rpm
Bowl length:	1260 mm
Bowl diameter:	280 mm
Beach angle:	10°
Solids discharge type:	360°-type with 6 wear liners
Solids transportation aids, cylindrical section:	Ribs
Solids transportation aids, taper section:	Ribs
Material - hubs:	AL 111 2349-02 (AISI 316)
Material - bowl shell:	AL 111 2349-83 (AISI 316)
Material - bolts:	A4-80 (AISI 316)
Material - seals:	
Liquid outlet, type:	4
Liquid outlet, radius:	84 mm (fitted from factory: 86 mm)

### Conveyor

Material - flights:	AL 111 2349 (AISI 316)
Material - hub:	AL 111 2349 (AISI 316)

### Wear Protection

Bowl solids discharge:	Wear liner in Tungsten Carbide, 6 pieces Part No. 61240340-03
Bowl feed zone liner:	
Conveyor flights:	TM42 (flame sprayed tungsten carbide) / none
Conveyor feed zone:	Flame sprayed tungsten carbide
Frame / casing:	Wear liner in upper casing

### Frame and Casing

Material - casing / cover:	Stainless steel (AISI 316)
Inside surface of casing:	Liners of stainless steel at discharge areas - painting in neutral compartment
Gaskets / seals - casing:	

## Drives

Power supply:	3 x 380 V / 50 Hz
Gearbox, type:	Planetary - 2-stage
Gearbox, max. torque:	1.5 kNm
Gearbox, ratio:	1:97.2
Back drive:	Variable Frequency Drive 7.5 kW IEC (400V, 50Hz) - max. diff. speed 39 rpm at 1.5 kNm (Back drive motor, 400VD, 3000rpm, 50Hz, IEC 160, part no. 61195702-00)
Back drive parts:	
Operating main speed:	4400 rpm (IEC)
Max. diff. speed and torque (at operating speed):	39 rpm / 1.5 kNm
G-force at operating speed:	3030 G
Main motor:	15 kW ABB 400VD Y/D-VFD (160) flange – part No. 61195704-01
Main motor, protection:	

## Documents & Drawings

Manuals, language:	Manuals in English
Dimension drawing:	61243714
Diagram, decanter junction box:	61244583

## Spare Parts

**Important:** When ordering spare parts, always state:  
 Machine number and type indicated above  
 Part number and designation  
 Quantity

The decanter centrifuge complies with the essential health and safety requirements of council directives

2006/42/EC	Machinery Directive
2006/95/EC	Low Voltage Directive
2004/108/EC	EMC Directive

To meet the requirements, the harmonised standard EN 12547 has been used.

The technical file for decanter centrifuge is compiled and retained by Product Centre Decanters, Alfa Laval Copenhagen A/S, Maskinvej 5, DK-2860 Søborg, Denmark. Authorised person: Jan Cederkvist, Mechanical Technology.

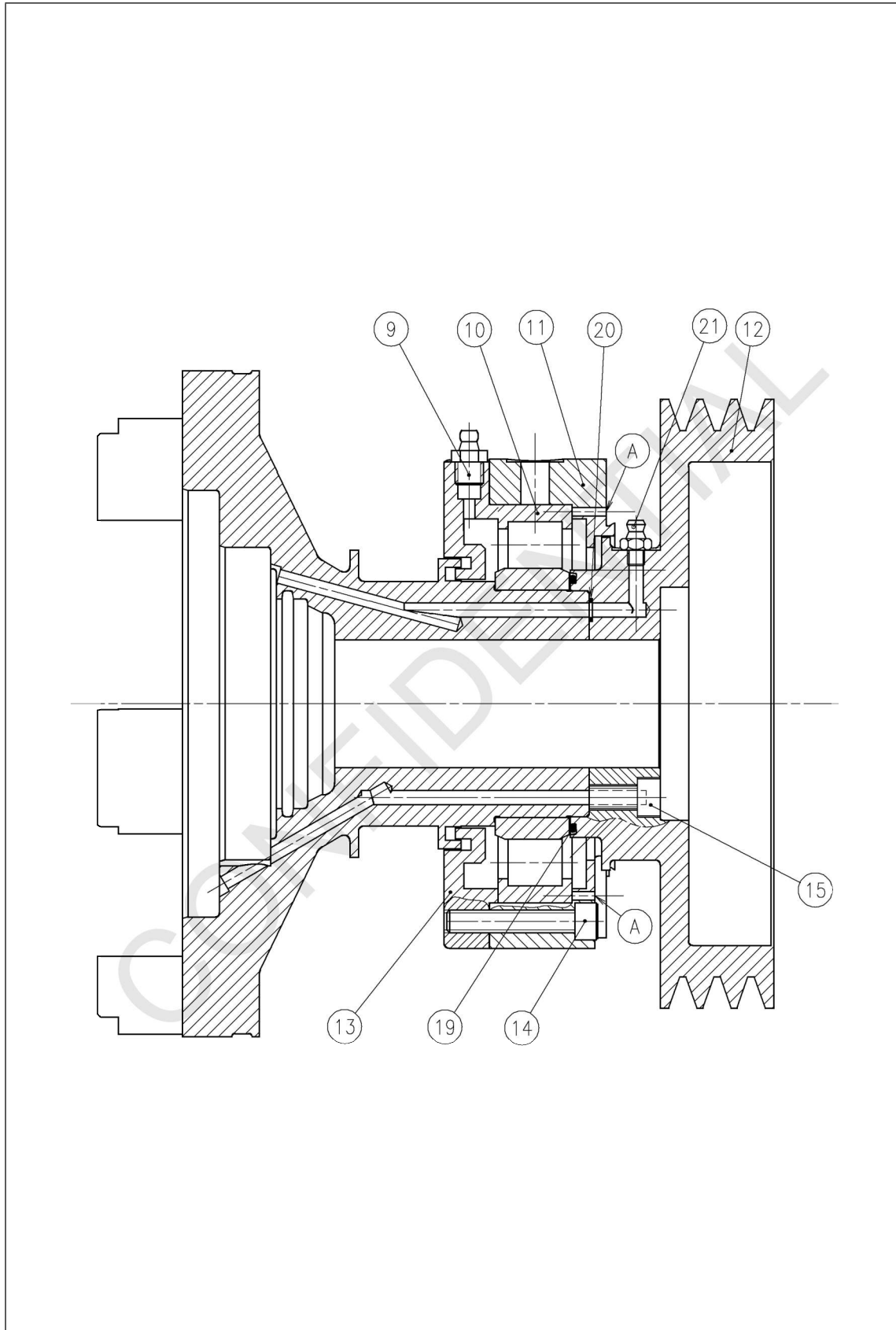

Figure 4.2.3