

Lembar data produk

Spesifikasi



TeSys GV2-Circuit breaker- thermal-magnetic - 4...6.3 A - screw clamp terminals

GV2ME10

Main

Range	TeSys Deca
Product name	TeSys GV2
Product or component type	Motor circuit breaker
Device short name	GV2ME
Device application	Motor protection
Trip unit technology	Thermal-magnetic

Complementary

Poles description	3P
Network type	AC
Utilisation category	Category A conforming to IEC 60947-2 AC-3 conforming to IEC 60947-4-1 AC-3e conforming to IEC 60947-4-1
Network frequency	50/60 Hz conforming to IEC 60947-4-1
Motor power kW	2.2 kW at 400/415 V AC 50/60 Hz 3 kW at 500 V AC 50/60 Hz 4 kW at 690 V AC 50/60 Hz
Breaking capacity	100 kA Icu at 230/240 V AC 50/60 Hz conforming to IEC 60947-2 100 kA Icu at 400/415 V AC 50/60 Hz conforming to IEC 60947-2 50 kA Icu at 440 V AC 50/60 Hz conforming to IEC 60947-2 50 kA Icu at 500 V AC 50/60 Hz conforming to IEC 60947-2 3 kA Icu at 690 V AC 50/60 Hz conforming to IEC 60947-2
[Ics] rated service short-circuit breaking capacity	100 % at 230/240 V AC 50/60 Hz conforming to IEC 60947-2 100 % at 400/415 V AC 50/60 Hz conforming to IEC 60947-2 100 % at 440 V AC 50/60 Hz conforming to IEC 60947-2 100 % at 500 V AC 50/60 Hz conforming to IEC 60947-2 75 % at 690 V AC 50/60 Hz conforming to IEC 60947-2
Control type	Push-button
[In] rated current	6.3 A
Thermal protection adjustment range	4...6.3 A conforming to IEC 60947-4-1
Magnetic tripping current	91 A
[Ith] conventional free air thermal current	6.3 A conforming to IEC 60947-4-1
[Ue] rated operational voltage	690 V AC 50/60 Hz conforming to IEC 60947-2
[Ui] rated insulation voltage	690 V AC 50/60 Hz conforming to IEC 60947-2
[Uimp] rated impulse withstand voltage	6 kV conforming to IEC 60947-2
Phase failure sensitivity	Yes conforming to IEC 60947-4-1
Suitability for isolation	Yes conforming to IEC 60947-1

Power dissipation per pole	2.5 W
Mechanical durability	100000 cycles
Electrical durability	100000 cycles for AC-3 at 415 V In 100000 cycles for AC-3e at 415 V In
Rated duty	Continuous conforming to IEC 60947-4-1
Tightening torque	1.7 N.m - on screw clamp terminal
Mounting position	Horizontal Vertical
Width	45 mm
Height	89 mm
Depth	78.5 mm
Net weight	0.26 kg
Colour	Dark grey

Environment

Standards	EN/IEC 60947-2 EN/IEC 60947-4-1 UL 60947-4-1 CSA C22.2 No 60947-4-1 IEC/EN 60335-2-40:Annex JJ IEC/EN 60335-1:Clause 30.2
Product certifications	CCC UL CSA EAC ATEX LROS (Lloyds register of shipping) BV RINA DNV-GL UKCA
IK degree of protection	IK04
IP degree of protection	IP20 conforming to IEC 60529
Climatic withstand	conforming to IACS E10
Ambient air temperature for storage	-40...80 °C
Fire resistance	960 °C conforming to IEC 60695-2-11
Ambient air temperature for operation	-20...60 °C
Mechanical robustness	Shocks: 30 Gn for 11 ms Vibrations: 5 Gn, 5...150 Hz
Operating altitude	2000 m

Packing Units

Unit Type of Package 1	PCE
Number of Units in Package 1	1
Package 1 Height	9.300 cm
Package 1 Width	4.800 cm
Package 1 Length	8.500 cm
Package 1 Weight	271.000 g
Unit Type of Package 2	S02

Number of Units in Package 2	24
Package 2 Height	15.000 cm
Package 2 Width	30.000 cm
Package 2 Length	40.000 cm
Package 2 Weight	6.832 kg

Contractual warranty

Warranty	12 months
-----------------	-----------

Keberlanjutan

Green Premium™ label adalah komitmen Schneider Electric untuk memberikan produk dengan performa lingkungan terbaik di kelasnya. Green Premium menjanjikan kepatuhan pada peraturan terbaru, transparansi pada dampak lingkungan, serta produk melingkar dan rendah CO₂.

Panduan untuk menilai keberlanjutan produk adalah laporan resmi yang menjelaskan standar label lingkungan global dan bagaimana menafsirkan deklarasi lingkungan.

[Pelajari lebih lanjut tentang Green Premium >](#)

[Panduan untuk menilai keberlanjutan produk >](#)



Transparansi RoHS/REACH

Kinerja kesejahteraan

Mercury Free

Rohs Exemption Information [Yes](#)

Sertifikasi & Standar

Reach Regulation [REACH Declaration](#)

Eu Rohs Directive Compliant with Exemptions

China Rohs Regulation [China RoHS declaration](#)
Product out of China RoHS scope. Substance declaration for your information

Environmental Disclosure [Product Environmental Profile](#)

Weee The product must be disposed on European Union markets following specific waste collection and never end up in rubbish bins

Circularity Profile [End of Life Information](#)

Performance Curves

Thermal-Magnetic Tripping Curves for GV2ME and GV2P
 Average Operating Times at 20 °C Related to Multiples of the Setting Current



- 1 3 poles from cold state
- 2 2 poles from cold state
- 3 3 poles from hot state

Current Limitation on Short-Circuit for GV2ME and GV2P (3-Phase 400/415 V)

Dynamic Stress

$I_{peak} = f(\text{prospective } I_{sc}) \text{ at } 1.05 U_e = 435 \text{ V}$



- 1 Maximum peak current
- 2 24-32 A
- 3 20-25 A
- 4 17-23 A
- 5 13-18 A
- 6 9-14 A
- 7 6-10 A
- 8 4-6.3 A
- 9 2.5-4 A
- 10 1.6-2.5 A
- 11 1-1.6 A
- 12 Limit of rated ultimate breaking capacity on short-circuit of GV2ME (14, 18, 23, and 25 A ratings).

Thermal Limit on Short-Circuit for GV2ME

Thermal Limit in kA^2s in the Magnetic Operating Zone

Sum of $I^2dt = f$ (prospective Isc) at 1.05 Ue = 435 V



- 1 24-32 A
- 2 20-25 A
- 3 17-23 A
- 4 13-18 A
- 5 9-14 A
- 6 6-10 A
- 7 4-6.3 A
- 8 2.5-4 A
- 9 1.6-2.5 A
- 10 1-1.6 A

Dimensions Drawings

Dimension

GV2ME

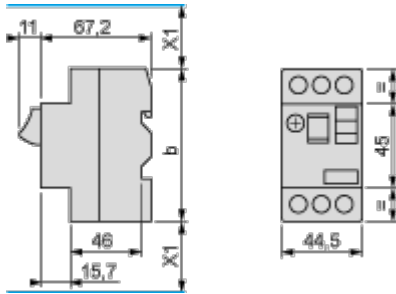

(1) Maximum

X1 Electrical clearance = 40 mm for $U_e \leq 690$ V

	b
GV2ME $\bullet\bullet$	89
GV2ME $\bullet\bullet$ 3	101

Mounting

GV2ME

On 35 mm rail

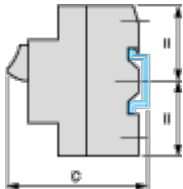

c = 78.5 on AM1 DP200 (35 x 7.5)

c = 86 on AM1 DE200, ED200 (35 x 15)

On panel with adapter plate GV2AF02

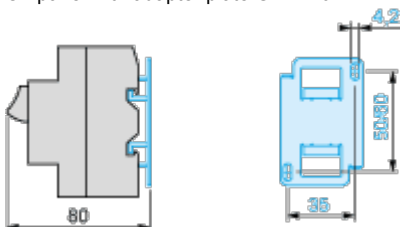

On pre-slotted plate AM1 PA

AF1 EA4

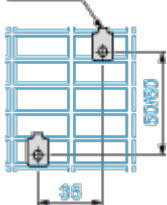

On rails DZ5 MB201

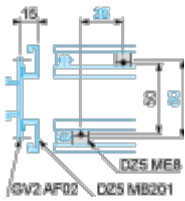

GV2AF01

Combination GV2ME + TeSys k contactor

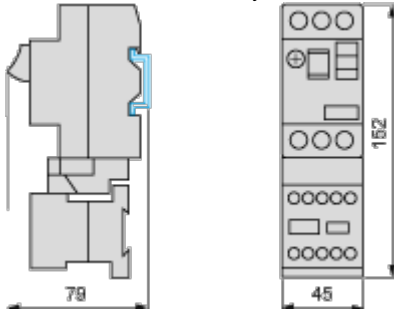

GV2AF3

Combination GV2ME + TeSys d contactor

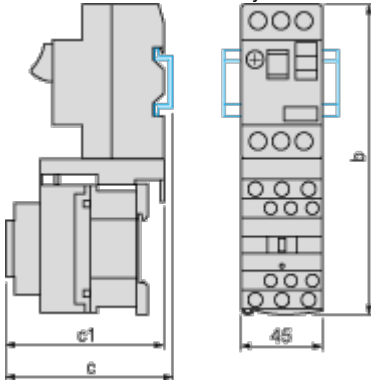

GV2ME +	LC1D09...D18	LC1D25 and D32
b	176.4	186.8
c1	94.1	100.4
c	99.6	105.9

GV2AF4 + LAD311

Combination GV2ME + TeSys d contactor



GV2ME +	LC1D09...D18	LC1D25 and D32
b	176.4	186.8
c1	103.1	136.4
c	135.6	141.9
d1	107	107
d	112.5	112.5

GV2ME + GV1L3 (Current Limiter)



X1 = 10 mm for Ue = 230 V or 30 mm for 230 V < Ue ≤ 690 V

Connections and Schema

GV2ME•• and GV2RT



Connection of Undervoltage Trip for Dangerous Machines (Conforming to INRS) on GV2ME Only

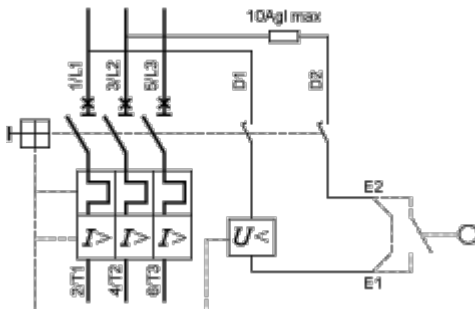

Technical Illustration

Wiring diagram

GV2ME \times

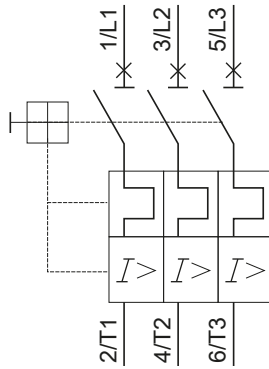

REFER TO TECHNICAL DRAWINGS AND DOCUMENTATION FOR COMPLETE INFORMATION.

Image of product / Alternate images

Alternative

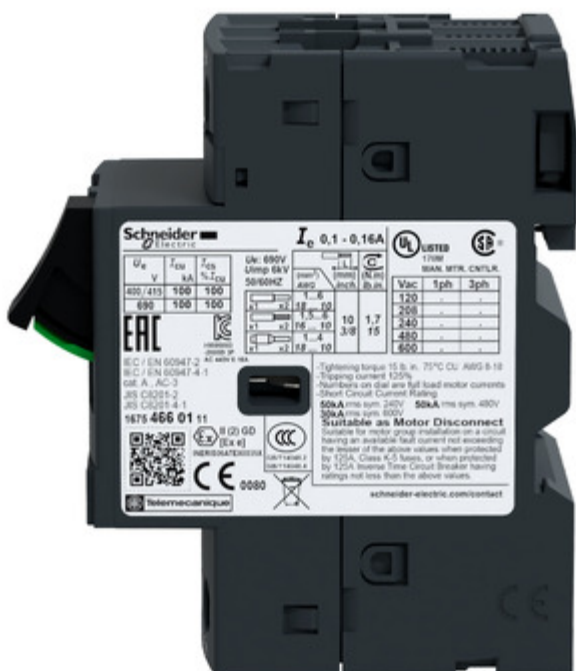
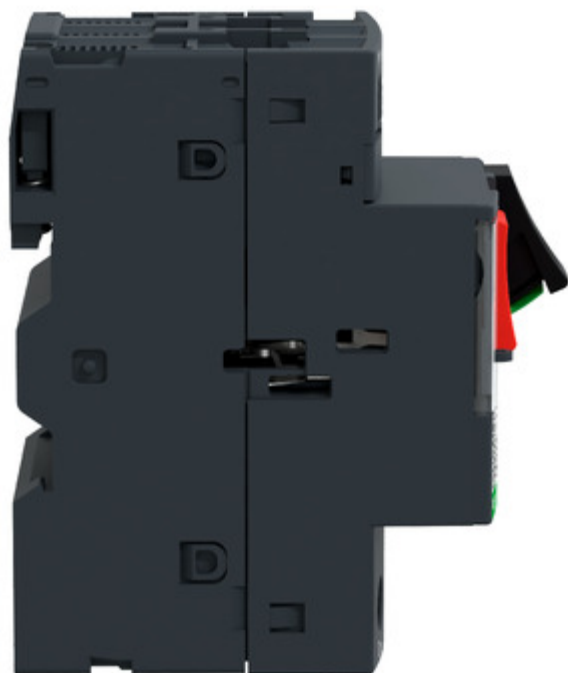

Schneider Electric

I_e 0,1 - 0,16A

UL LISTED 17000
SEAN MTR. CNTLR.

U _e	I _{cu}	I _{cs}	U _e	I _{cu}	I _{cs}
V	kA	%I _{cu}	V	kA	%I _{cu}
400/415	100	100	120	-	-
480	100	100	208	-	-
575	100	100	240	-	-
690	100	100	480	-	-
			600	-	-

UL: 690V
U_{imp} 6kV
50/60Hz

U _e	I _{cu}	I _{cs}
120	10	1,7
208	3/8	15
240	10	1,7
480	3/8	15
600	10	1,7

ERAC

IEC/EN 60947-2
IEC/EN 60947-4-1
SAB, A, AC-3
JIS C1224-2
JIS C1224-4-1

1675 466 01 11

0 (2) GD
[Xk v]
INDEPENDENT
0080

Schneider Electric

schneider-electric.com/contact

Suitable as Motor Disconnect
Suitable for motor group installation on a circuit having an available fault current not exceeding the lesser of the above values when protected by 125A Class K-3 fuses, or when protected by 125A Inverse Time Circuit Breaker having ratings not less than the above values.

