

Genset Center



# Assembling Part

# Catalogue



 **Perkins - Stamford**  
Generating Set

Nang'08

# Perkins - Stamford Generating Set

## PL30SM

Perkins Engine 1103A-33G  
Stamford BCI184G1

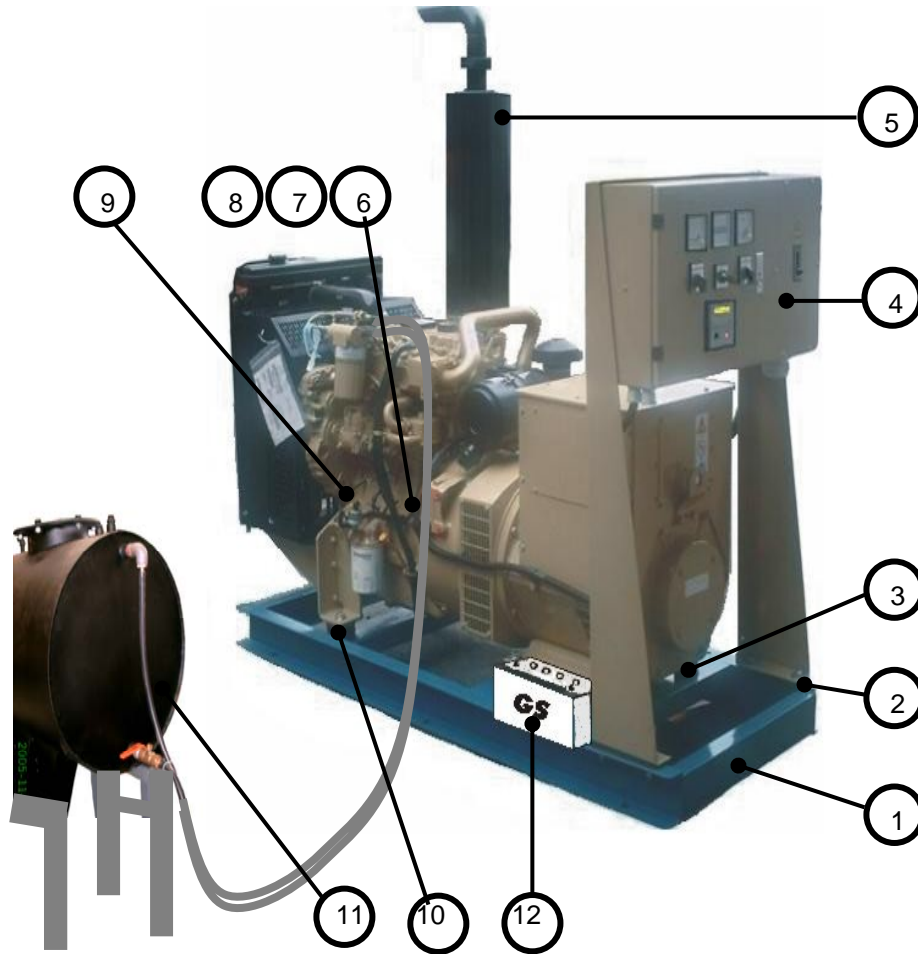

No	Part No	Part Name	Qty
1	7JC-51-11000-C	Base Frame	1
2	7AE-06-12000-SM	Rubber Mounting Panel SM	2
3	7AC-782-1000	Rubber Mounting Geno	4
4	7AC-06-30000-SM	Panel Assy	1
	7AE-06-32000-SM	- Bracket Panel	1
5	7AE-972-10000	Muffler Assy	1
	7AE-972-1100-A	- Muffler	1
	7AE-972-12500	- Elbow (Extension Muffler)	1
	7AE-04-12500	- Pipe S/A	1
	7AC-04-12000	- Flexible	1
6	7AE-07-10000-SM	Harness Loom	1
7	323-803-001-019D	Cooling Temp. Sender	1
8	4RA003510-08	Relay Starting motor	1
9	360-081-029-001	Oil Pressure Sender	1
	7AC-05-3001	- Adaptor, Oil Sender	2
10	7JE-783-2000-A	Rubber Mounting Engine	2
11	7AE-947-1000-CS	Fuel Tank c/w Support	1
	H025B	- Fuel Hose	2
	NP05025	- Nipple ½"	2
	7AE-947-0000	-Ball Valve ½"	1
12	B-8040-0-1000	Battery N100	1
	B-8100-0-0250	Cable Battery 1000	2
	B-8018-0-0708	Terminal Battery (+) (-)	1
13	B-9014-0-1000	Tool Set	1

# Perkins - Stamford Generating Set

## PL30SM Panel Engine

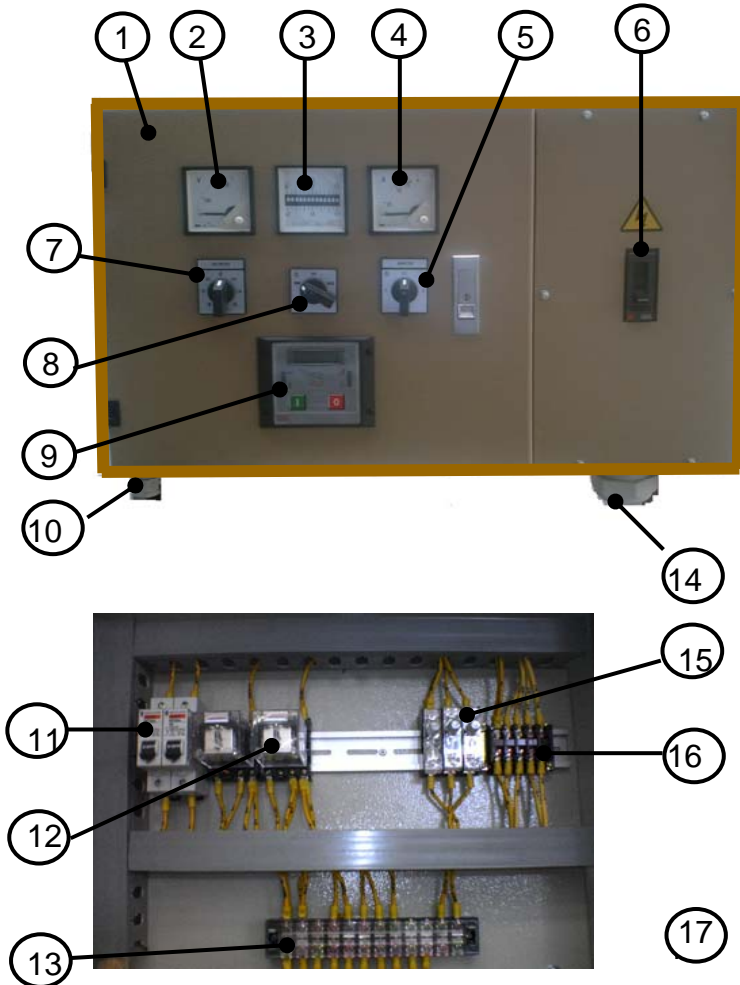

No	Part No	Part Name	Qty
1	7AE-06-30001-SM	Box Panel Assy	1
2	VM500-72	AC Voltmeter	1
3	FM4654-72	Frequency Meter	1
4	AM50-72	AC Ammeter	1
5	ASS4P	Ammeter Selector Switch	1
6	NS100NTM50D	Breaker (MCCB)	1
7	VSS7P	Voltmeter Selector Switch	1
8	ASSS3P	Auto Selector Switch	1
9	9000-0039	EMS 39	1
10	PG-21	Cable Gland	3
11	MCB6A1P	MCB	2
12	B-8308-0-0120	Relay Omron, DC	2
	- PF083A	Socket Relay Omron	2
13	TB114F	Terminal Block	1
14	PG-53	Cable Gland	2
15	FS10-AUS	Holder, Fuse	2
	- F10AC	Fuse 10A AC	2
16	TB110TR	Terminal Block 5 A	5
17	CT70-50	Current Transformer	3

# Perkins - Stamford Generating Set

## PL45SM

Perkins Engine 1103A-33TG1  
Stamford UCI224C1

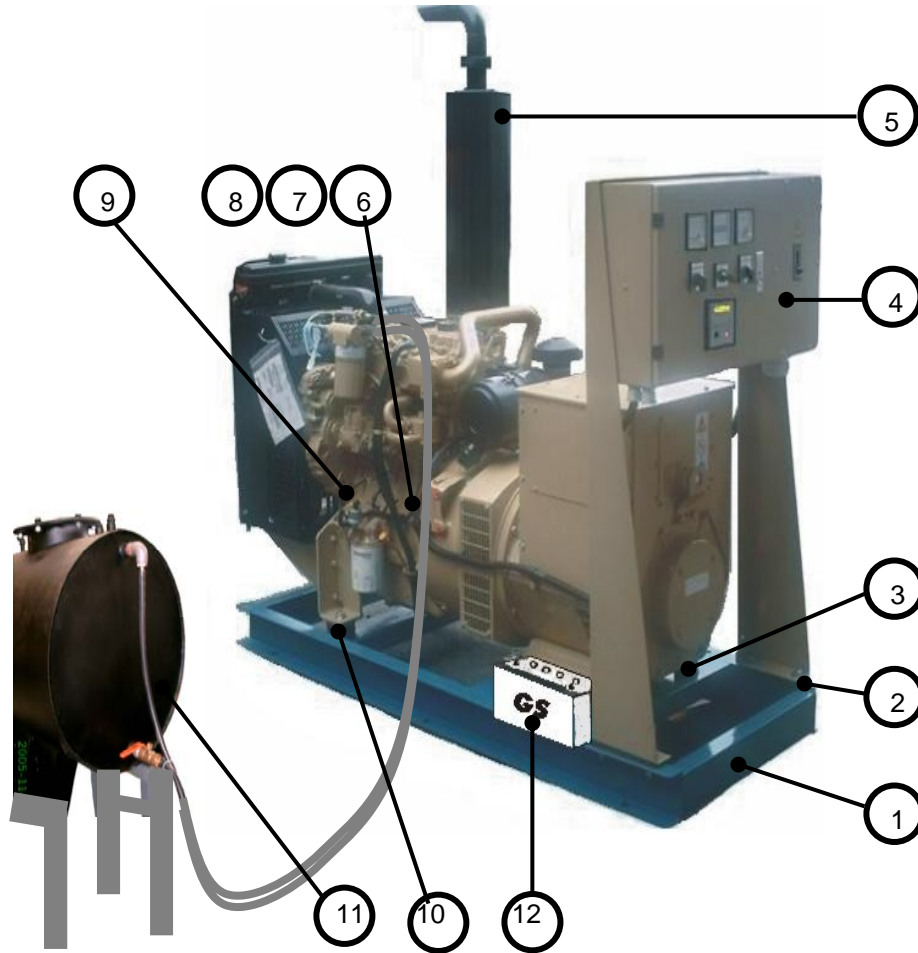

No	Part No	Part Name	Qty
1	7JC-51-11000-C	Base Frame	1
2	7AE-06-12000-SM	Rubber Mounting Panel SM	2
3	7AC-782-1000	Rubber Mounting Geno	4
4	7AE-06-30000-SM	Panel Assy	1
	7AE-06-32000-SM	- Bracket Panel	1
5	7AE-972-10000	Muffler Assy	1
	7AE-972-1100-A	- Muffler	1
	7AE-972-12500	- Elbow (Extension Muffler)	1
	7AE-04-12500	- Pipe S/A	1
	7AC-04-12000	- Flexible	1
6	7AE-07-10000-SM	Harness Loom	1
7	323-803-001-019D	Cooling Temp. Sender	1
8	4RA003510-08	Relay Starting motor	1
9	360-081-029-001	Oil Pressure Sender	1
	7AC-05-3001	- Adaptor, Oil Sender	2
10	7JE-783-2000-A	Rubber Mounting Engine	2
11	7AE-947-1000-CS	Fuel Tank c/w Support	1
	H025B	- Fuel Hose	2
	NP05025	- Nipple ½"	2
	7AE-947-0000	-Ball Valve ½"	1
12	B-8040-0-1000	Battery N100	1
	B-8100-0-0250	Cable Battery 1000	2
	B-8018-0-0708	Terminal Battery (+) (-)	1
13	B-9014-0-1000	Tool Set	1



# Perkins - Stamford Generating Set

## PL45SM Panel Engine

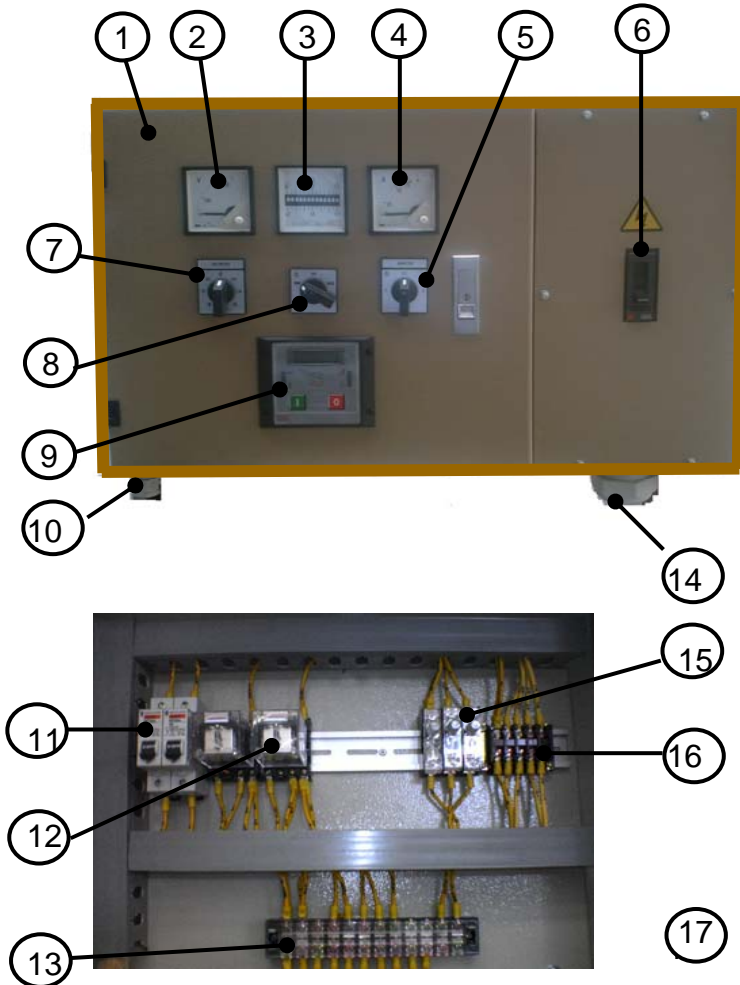

No	Part No	Part Name	Qty
1	7AE-06-30001-SM	Box Panel Assy	1
2	VM500-72	AC Voltmeter	1
3	FM4654-72	Frequency Meter	1
4	AM75-72	AC Ammeter	1
5	ASS4P	Ammeter Selector Switch	1
6	NS100NTM80D	Breaker (MCCB)	1
7	VSS7P	Voltmeter Selector Switch	1
8	ASSS3P	Auto Selector Switch	1
9	9000-0039	EMS 39	1
10	PG-21	Cable Gland	3
11	MCB6A1P	MCB	2
12	B-8308-0-0120	Relay Omron, DC	2
	- PF083A	Socket Relay Omron	2
13	TB114F	Terminal Block	1
14	PG-53	Cable Gland	2
15	FS10-AUS	Holder, Fuse	2
	- F10AC	Fuse 10A AC	2
16	TB110TR	Terminal Block 5 A	5
17	CT70-75	Current Transformer	3

# Perkins - Stamford Generating Set

## PL60SM

Perkins Engine 1103A-33TG2  
Stamford UCI224E1

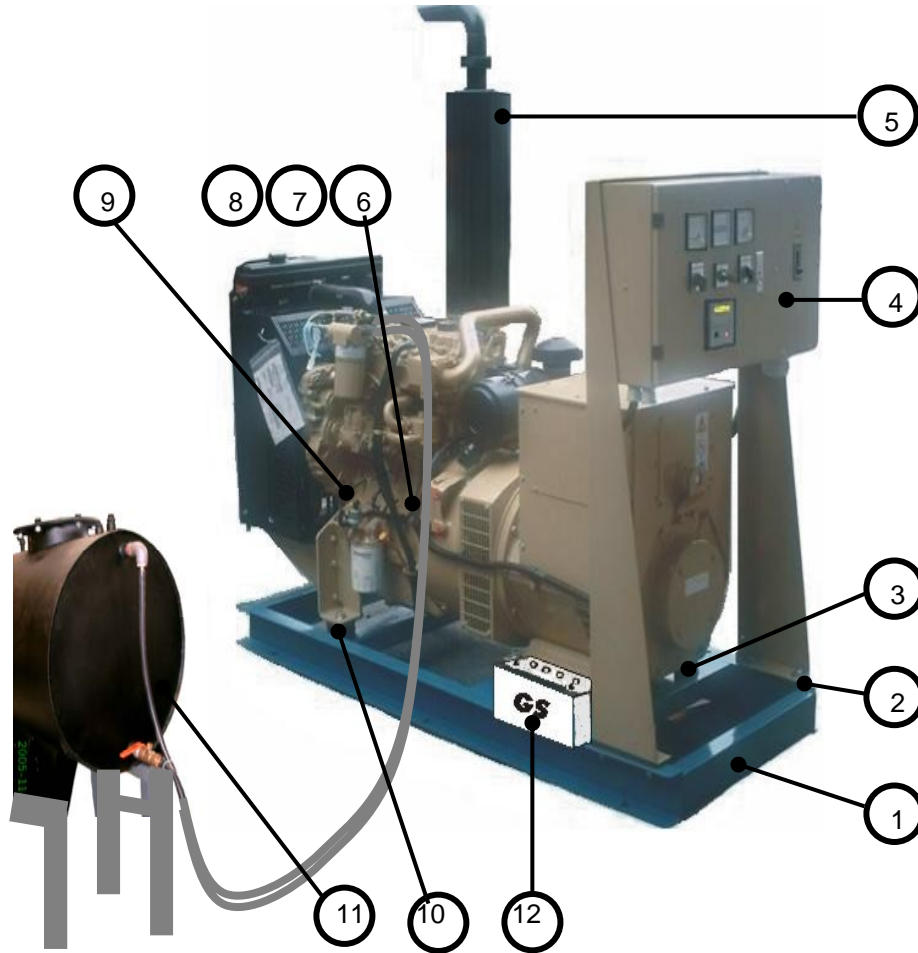

No	Part No	Part Name	Qty
1	7JC-51-11000-C	Base Frame	1
2	7AE-06-12000-SM	Rubber Mounting Panel SM	2
3	7AC-782-1000	Rubber Mounting Geno	4
4	7AF-06-30000-SM	Panel Assy	1
	7AE-06-32000-SM	- Bracket Panel	1
5	7AE-972-10000	Muffler Assy	1
	7AE-972-1100-A	- Muffler	1
	7AE-972-12500	- Elbow (Extension Muffler)	1
	7AE-04-12500	- Pipe S/A	1
	7AC-04-12000	- Flexible	1
6	7AE-07-10000-SM	Harness Loom	1
7	323-803-001-019D	Cooling Temp. Sender	1
8	4RA003510-08	Relay Starting motor	1
9	360-081-029-001	Oil Pressure Sender	1
	7AC-05-3001	- Adaptor, Oil Sender	2
10	7JE-783-2000-A	Rubber Mounting Engine	2
11	7AE-947-1000-CS	Fuel Tank c/w Support	1
	H025B	- Fuel Hose	2
	NP05025	- Nipple ½"	2
	7AE-947-0000	-Ball Valve ½"	1
12	B-8040-0-1000	Battery N100	1
	B-8100-0-0250	Cable Battery 1000	2
	B-8018-0-0708	Terminal Battery (+) (-)	1
13	B-9014-0-1000	Tool Set	1

# Perkins - Stamford Generating Set

## PL60SM PL65SM Panel Engine

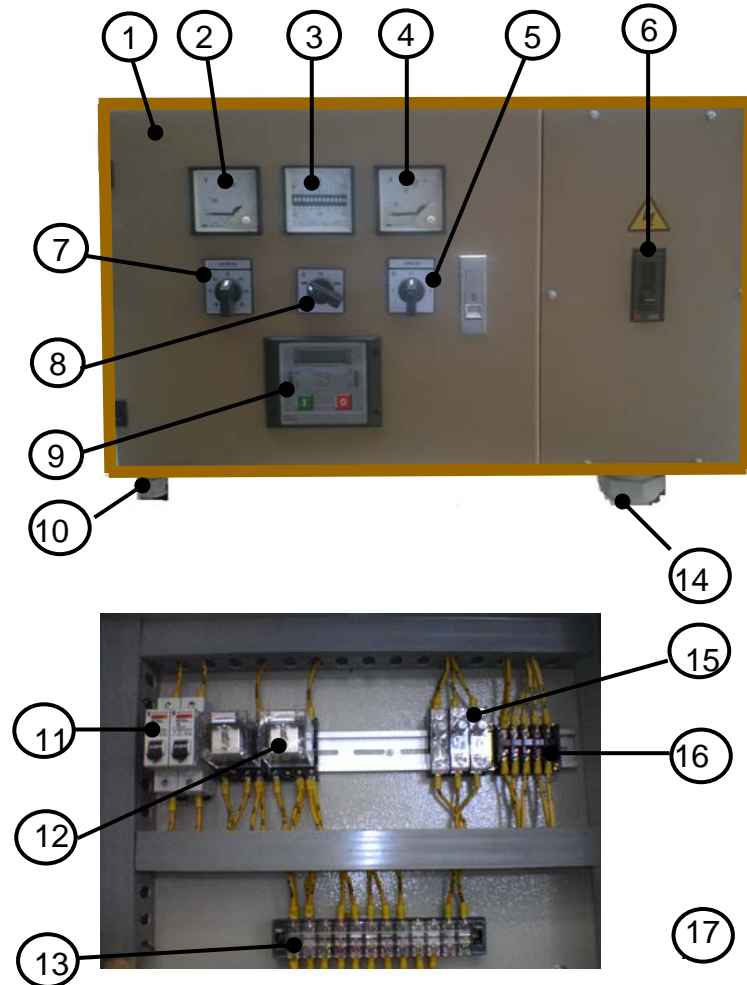

No	Part No	Part Name	Qty
1	7AE-06-30001-SM	Box Panel Assy	1
2	VM500-72	AC Voltmeter	1
3	FM4654-72	Frequency Meter	1
4	AM100-72	AC Ammeter	1
5	ASS4P	Ammeter Selector Switch	1
6	NS100NTM100D	Breaker (MCCB)	1
7	VSS7P	Voltmeter Selector Switch	1
8	ASSS3P	Auto Selector Switch	1
9	9000-0039	EMS 39	1
10	PG-21	Cable Gland	3
11	MCB6A1P	MCB	2
12	B-8308-0-0120	Relay Omron, DC	2
	- PF083A	Socket Relay Omron	2
13	TB114F	Terminal Block	1
14	PG-53	Cable Gland	2
15	FS10-AUS	Holder, Fuse	2
	- F10AC	Fuse 10A AC	2
16	TB110TR	Terminal Block 5 A	5
17	CT70-100	Current Transformer	3

# Perkins - Stamford Generating Set

## PL65SM

Perkins Engine 1104A-44TG1  
Stamford UCI224F1

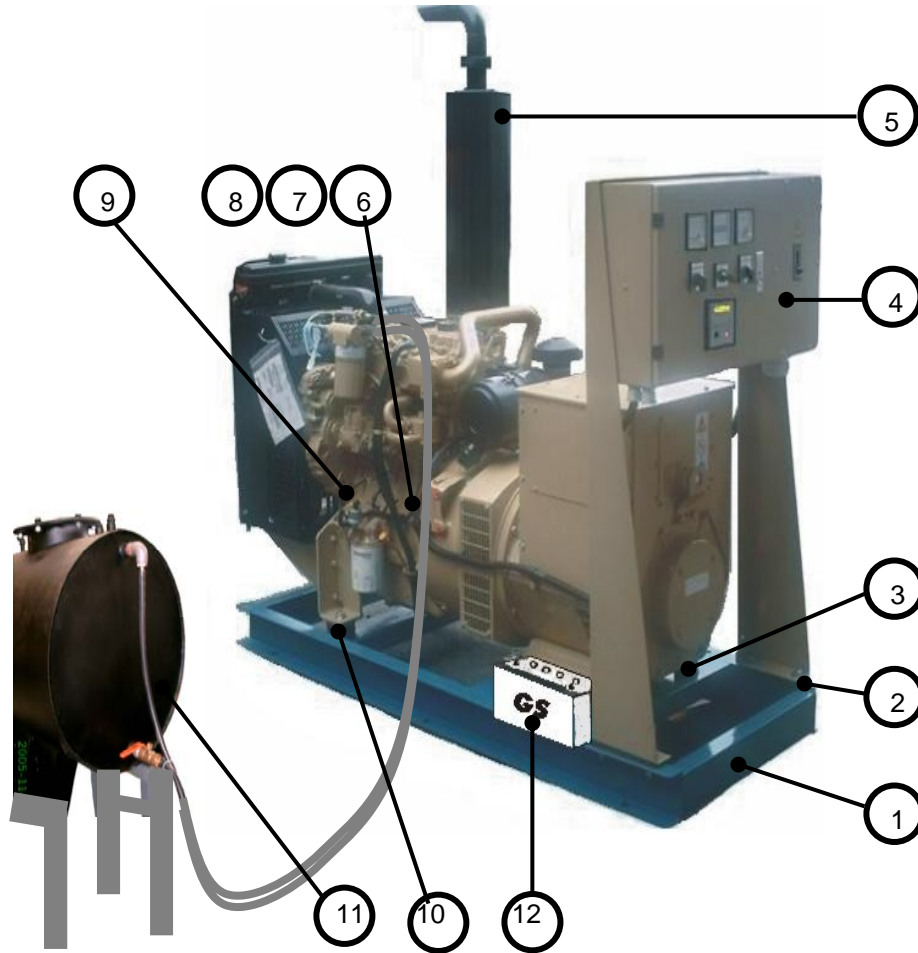

No	Part No	Part Name	Qty
1	7JE-51-11000-C	Base Frame	1
2	7AE-06-12000-SM	Rubber Mounting Panel SM	2
3	7AC-782-1000	Rubber Mounting Geno	4
4	7AF-06-30000-SM	Panel Assy	1
	7AE-06-32000-SM	- Bracket Panel	1
5	7AE-972-10000	Muffler Assy	1
	7AE-972-1100-A	- Muffler	1
	7AF-972-12500	- Elbow (Extension Muffler)	1
	7AF-04-12500	- Pipe S/A	1
	7AF-04-12000	- Flexible	1
6	7AF-07-10000-SM	Harness Loom	1
7	323-803-001-019D	Cooling Temp. Sender	1
8	4RA003510-08	Relay Starting motor	1
9	360-081-029-001	Oil Pressure Sender	1
	7AC-05-3001	- Adaptor, Oil Sender	2
10	7JE-783-2000-A	Rubber Mounting Engine	2
11	7AE-947-1000-CS	Fuel Tank c/w Support	1
	H025B	- Fuel Hose	2
	NP05025	- Nipple ½"	2
	7AE-947-0000	-Ball Valve ½"	1
12	B-8040-0-1000	Battery N100	1
	B-8100-0-0250	Cable Battery 1000	2
	B-8018-0-0708	Terminal Battery (+) (-)	1
13	B-9014-0-1000	Tool Set	1



# Perkins - Stamford Generating Set

## PL60SM PL65SM Panel Engine

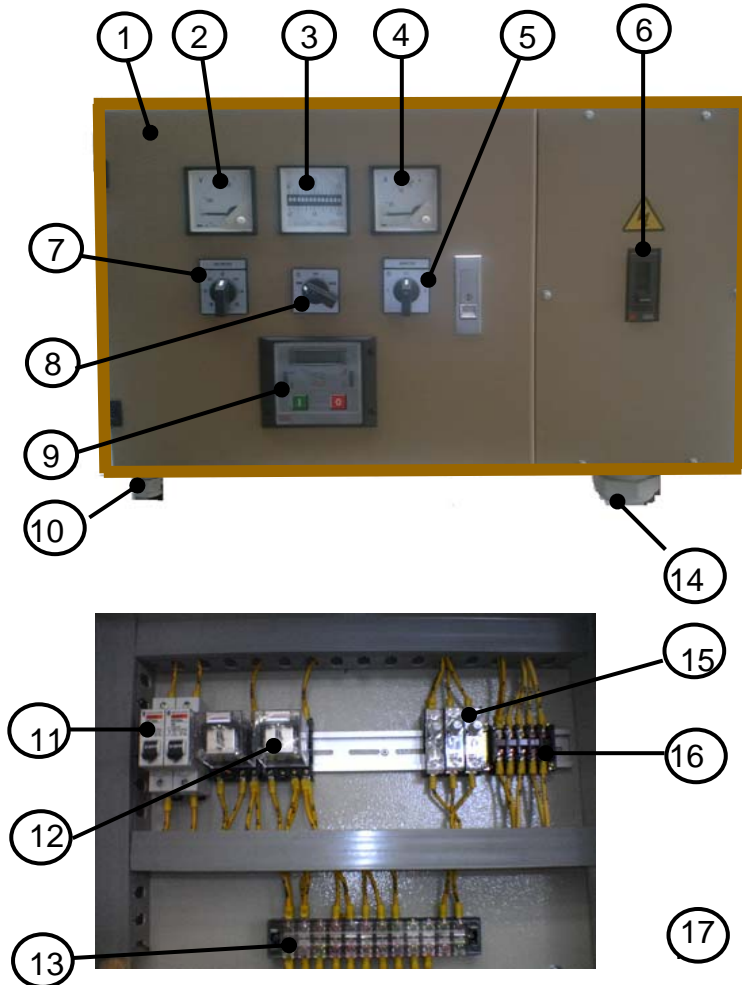

No	Part No	Part Name	Qty
1	7AE-06-30001-SM	Box Panel Assy	1
2	VM500-72	AC Voltmeter	1
3	FM4654-72	Frequency Meter	1
4	AM100-72	AC Ammeter	1
5	ASS4P	Ammeter Selector Switch	1
6	NS100NTM100D	Breaker (MCCB)	1
7	VSS7P	Voltmeter Selector Switch	1
8	ASSS3P	Auto Selector Switch	1
9	9000-0039	EMS 39	1
10	PG-21	Cable Gland	3
11	MCB6A1P	MCB	2
12	B-8308-0-0120	Relay Omron, DC	2
	- PF083A	Socket Relay Omron	2
13	TB114F	Terminal Block	1
14	PG-53	Cable Gland	2
15	FS10-AUS	Holder, Fuse	2
	- F10AC	Fuse 10A AC	2
16	TB110TR	Terminal Block 5 A	5
17	CT70-100	Current Transformer	3

# Perkins - Stamford Generating Set

## PL80SM

Perkins Engine 1104A-44TG2  
Stamford UCI224G1

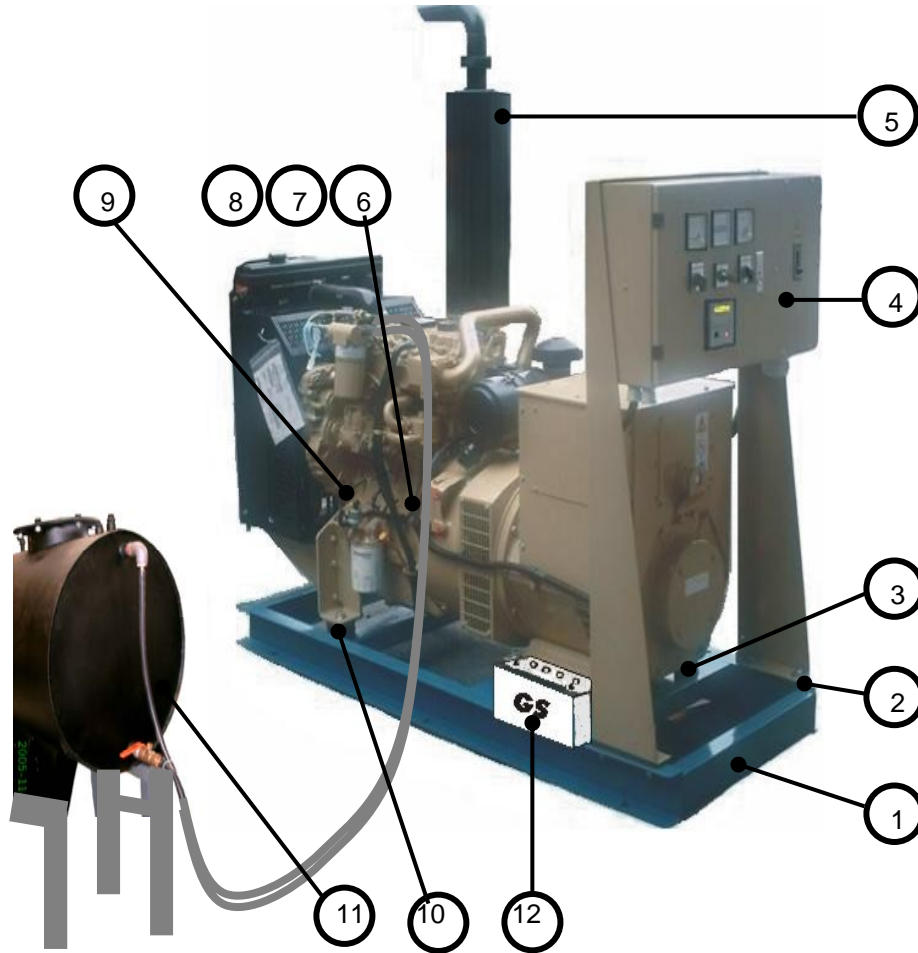

No	Part No	Part Name	Qty
1	7JE-51-11000-C	Base Frame	1
2	7AE-06-12000-SM	Rubber Mounting Panel SM	2
3	7AC-782-1000	Rubber Mounting Geno	4
4	7AA-06-30000-SM	Panel Assy	1
	7AE-06-32000-SM	- Bracket Panel	1
5	7AE-972-10000	Muffler Assy	1
	7AE-972-1100-A	- Muffler	1
	7AF-972-12500	- Elbow (Extension Muffler)	1
	7AF-04-12500	- Pipe S/A	1
	7AF-04-12000	- Flexible	1
6	7AF-07-10000-SM	Harness Loom	1
7	323-803-001-019D	Cooling Temp. Sender	1
8	4RA003510-08	Relay Starting motor	1
9	360-081-029-001	Oil Pressure Sender	1
	7AC-05-3001	- Adaptor, Oil Sender	2
10	7JE-783-2000-A	Rubber Mounting Engine	2
11	7AF-947-1000-CS	Fuel Tank c/w Support	1
	H025B	- Fuel Hose	2
	NP05025	- Nipple ½"	2
	7AE-947-0000	-Ball Valve ½"	1
12	B-8040-0-1000	Battery N100	1
	B-8100-0-0250	Cable Battery 1000	2
	B-8018-0-0708	Terminal Battery (+) (-)	1
13	B-9014-0-1000	Tool Set	1

# Perkins - Stamford Generating Set

## PL80SM Panel Engine

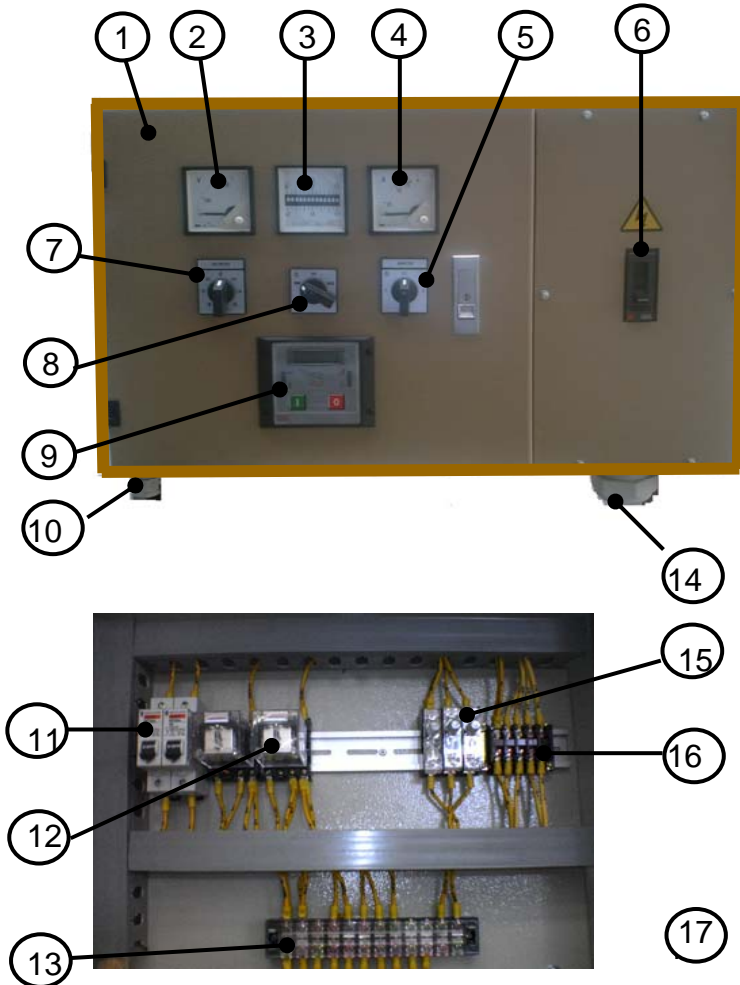

No	Part No	Part Name	Qty
1	7AE-06-30001-SM	Box Panel Assy	1
2	VM500-72	AC Voltmeter	1
3	FM4654-72	Frequency Meter	1
4	AM150-72	AC Ammeter	1
5	ASS4P	Ammeter Selector Switch	1
6	NS160NTM125D	Breaker (MCCB)	1
7	VSS7P	Voltmeter Selector Switch	1
8	ASSS3P	Auto Selector Switch	1
9	9000-0039	EMS 39	1
10	PG-21	Cable Gland	3
11	MCB6A1P	MCB	2
12	B-8308-0-0120	Relay Omron, DC	2
	- PF083A	Socket Relay Omron	2
13	TB114F	Terminal Block	1
14	PG-53	Cable Gland	2
15	FS10-AUS	Holder, Fuse	2
	- F10AC	Fuse 10A AC	2
16	TB110TR	Terminal Block 5 A	5
17	CT70-150	Current Transformer	3

# Perkins - Stamford Generating Set

## PL100 Perkins Engine 1006TG2A Stamford UCI274C1

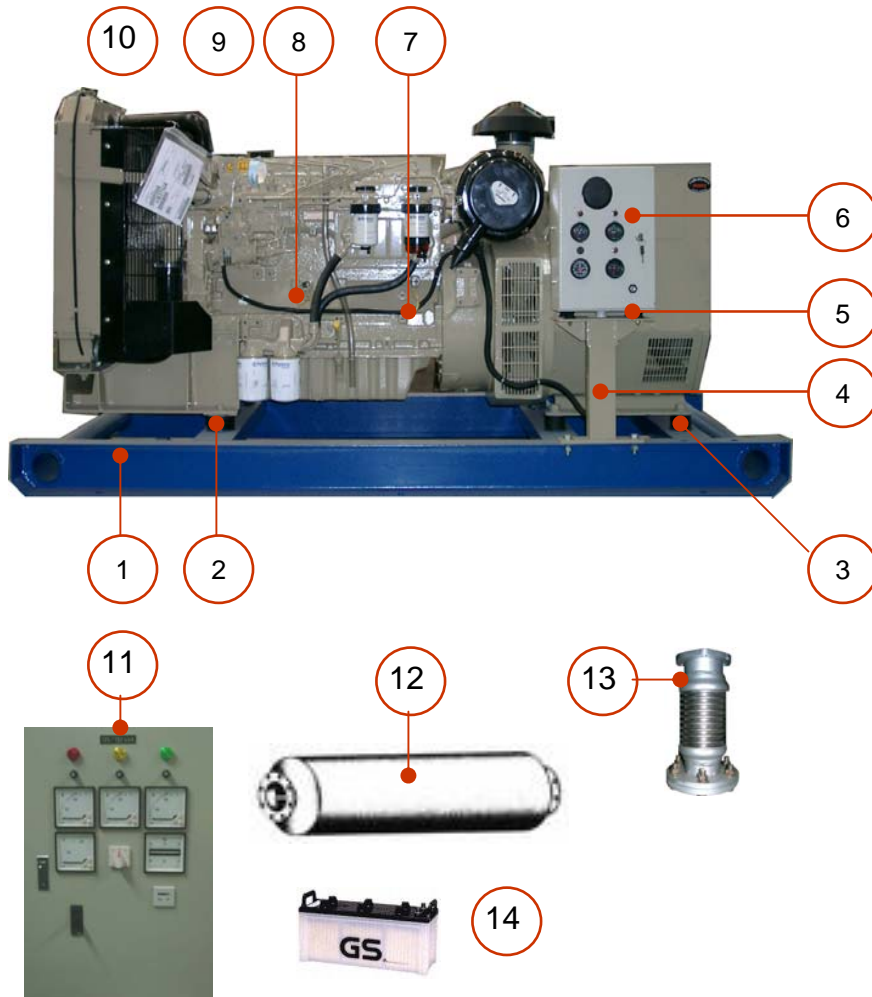

No	Part No	Part Name	Qty
1	7JH-51-10000-G	Base Frame	1
2	7JE-783-2000-A	Rubber Mounting E/G	2
3	7AG-782-1000-B	Rubber Mounting Geno	4
4	7AE-06-30001-C	Bracket Panel	1
5	7AE-06-12000	Rubber Mounting Panel	4
6	7AC-06-01200	Engine Control Panel	1
7	7AG-07-01000	Harness Loom	1
8	360-081-029-001	Oil Pressure Sender	1
9	323-803-001-019D	Cooling Temp. Sender	1
10	4RA003510-08	Relay Starting motor	1
11	7AG-09-00000	Wallmounted Panel	1
12	7AU-972-1100	Muffler 3"	1
13	7AG-04-10000	Flexible Pipe	1
14	B-8050-0-1200	Battery N120	1
	B-8100-0-0250	Cable Battery 1000	2
	B-8018-0-0708	Terminal Battery (+) (-)	1
15	B-9014-0-1000	Tool Set	1
16	7AF-947-1000-CS	Fuel Tank 200L	1



# Perkins - Stamford Generating Set

## PL100 Panel Engine

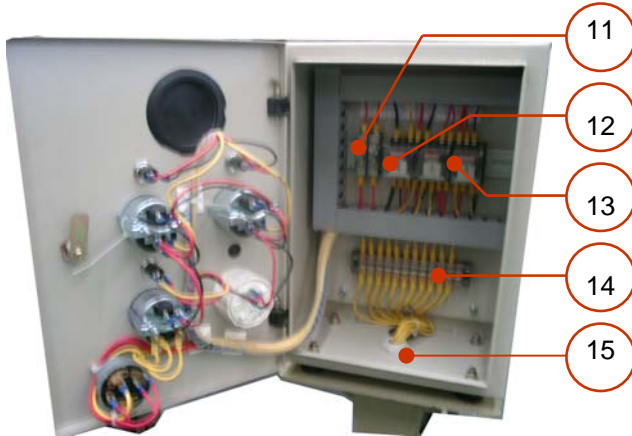
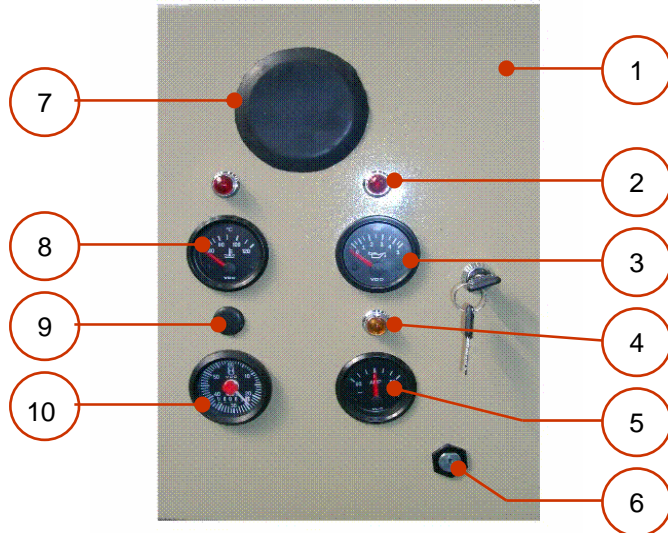

No	Part No	Part Name	Qty
1	7AJ-06-14000	Box Panel S/A	1
2	B-8116-0-0002	Case S/A Lamp, Red	2
	B-8100-1-0120	Bulb Lamp Indicator	2
3	350-030-003G	Oil Pressure Gauge	1
4	B-8116-0-0004	Case S/A Lamp, Yellow	1
	B-8100-1-0120	Bulb Lamp Indicator	1
5	190-037-002G	Ammeter Charging Gauge	1
6	2846130R	Key Starting	1
7	7AE-06-12101	Rubber Cap Tachometer	1
8	310-030-002G	Temperature Gauge	1
9	7AE-06-17000	Rubber Cap Lamp	1
10	331-810-012-002B	Hourmeter Gauge	1
11	FS10-AUS	Holder Fuse S/A	2
	F10DC	Fuse 10A DC	2
12	B-8808-0-0-0120	Relay Omron, AC	1
	PF083A	Socket Relay Omron	1
13	B-8308-0-0-0120	Relay Omron, DC	2
	PF083A	Socket Relay Omron	2
14	TB114F	Terminal Block	1
15	PG-21	Cable Gland	1

# Perkins - Stamford Generating Set

## PL135 Perkins Engine 1006TAG Stamford UCI274E1

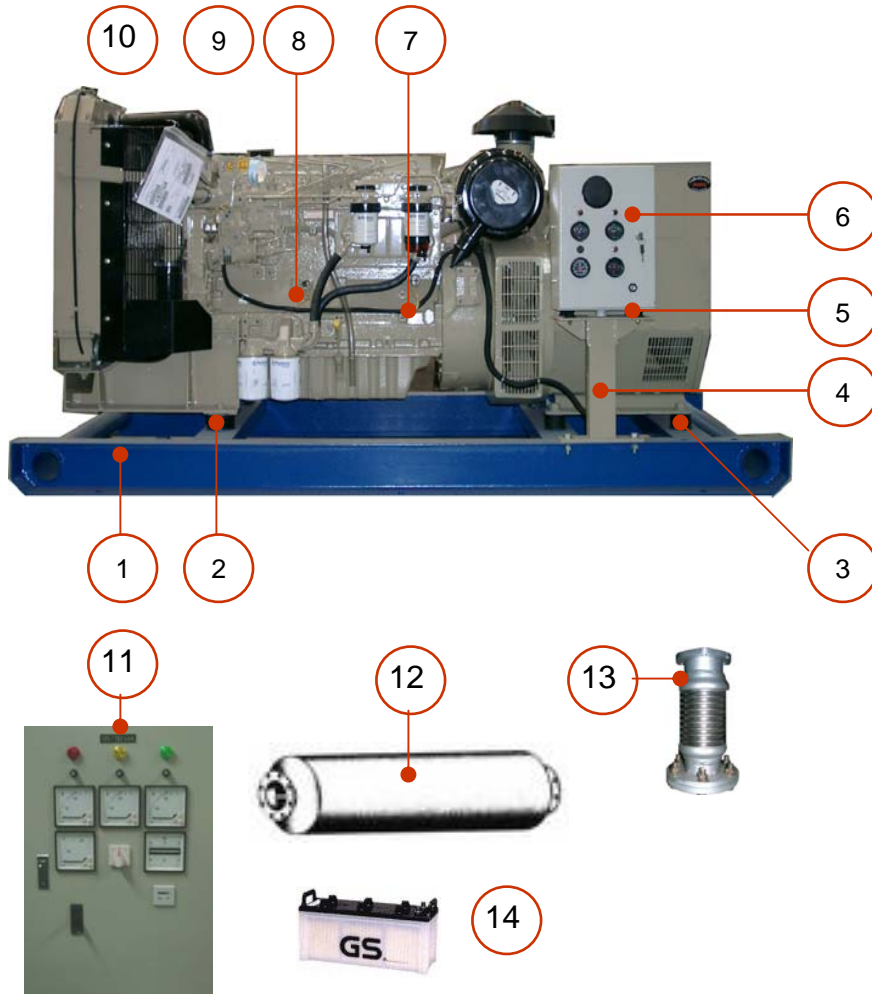

No	Part No	Part Name	Qty
1	7JH-51-10000-G	Base Frame	1
2	7JE-783-2000-A	Rubber Mounting E/G	2
3	7AG-782-1000-B	Rubber Mounting Geno	4
4	7AE-06-30001-C	Bracket Panel	1
5	7AE-06-12000	Rubber Mounting Panel	4
6	7AC-06-01200	Engine Control Panel	1
7	7AG-07-01000	Harness Loom	1
	AM-SOL	Jumper Cable LC (+)	1
	AB-MIN	Jumper Cable LC (-)	1
8	360-081-029-001	Oil Pressure Sender	1
9	323-803-001-019D	Cooling Temp. Sender	1
10	4RA003510-08	Relay Starting motor	1
11	7AI-09-13500	Wallmounted Panel	1
12	7AU-972-1100	Muffler 3"	1
13	7AG-04-10000	Flexible Pipe	1
14	B-8050-0-1200	Battery N120	1
	B-8100-0-0250	Cable Battery 1000	2
	B-8018-0-0708	Terminal Battery (+) (-)	1
15	B-9014-0-1000	Tool Set	1
16	7AF-947-1000-CS	Fuel Tank 200L	1

# Perkins - Stamford Generating Set

## PL135 Panel Engine

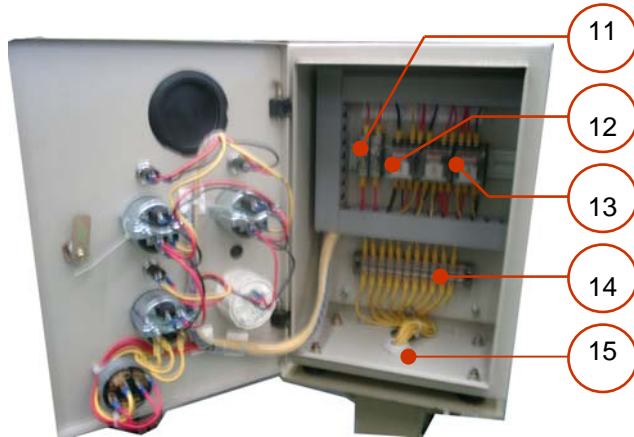
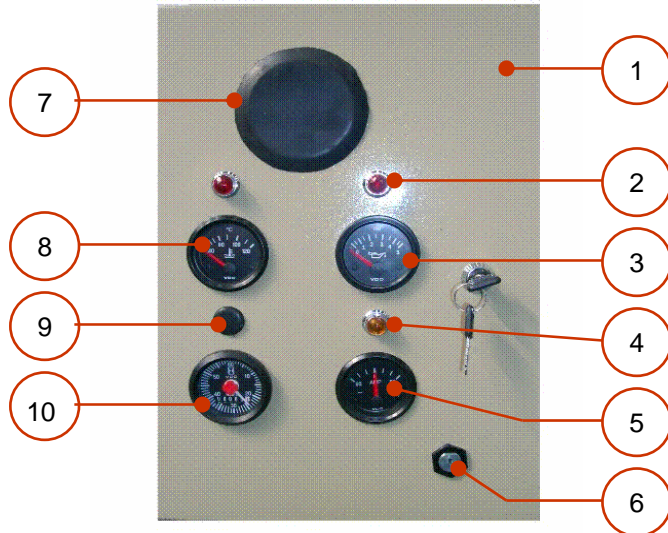

No	Part No	Part Name	Qty
1	7AJ-06-14000	Box Panel S/A	1
2	B-8116-0-0002	Case S/A Lamp, Red	2
	B-8100-1-0120	Bulb Lamp Indicator	2
3	350-030-003G	Oil Pressure Gauge	1
4	B-8116-0-0004	Case S/A Lamp, Yellow	1
	B-8100-1-0120	Bulb Lamp Indicator	1
5	190-037-002G	Ammeter Charging Gauge	1
6	2846130R	Key Starting	1
7	7AE-06-12101	Rubber Cap Tachometer	1
8	310-030-002G	Temperature Gauge	1
9	7AE-06-17000	Rubber Cap Lamp	1
10	331-810-012-002B	Hourmeter Gauge	1
11	FS10-AUS	Holder Fuse S/A	2
	F10DC	Fuse 10A DC	2
12	B-8808-0-0-0120	Relay Omron, AC	1
	PF083A	Socket Relay Omron	1
13	B-8308-0-0-0120	Relay Omron, DC	2
	PF083A	Socket Relay Omron	2
14	TB114F	Terminal Block	1
15	PG-21	Cable Gland	1

# Perkins - Stamford Generating Set

## PL150 Perkins Engine 1006TAG2 Stamford UCI274F1

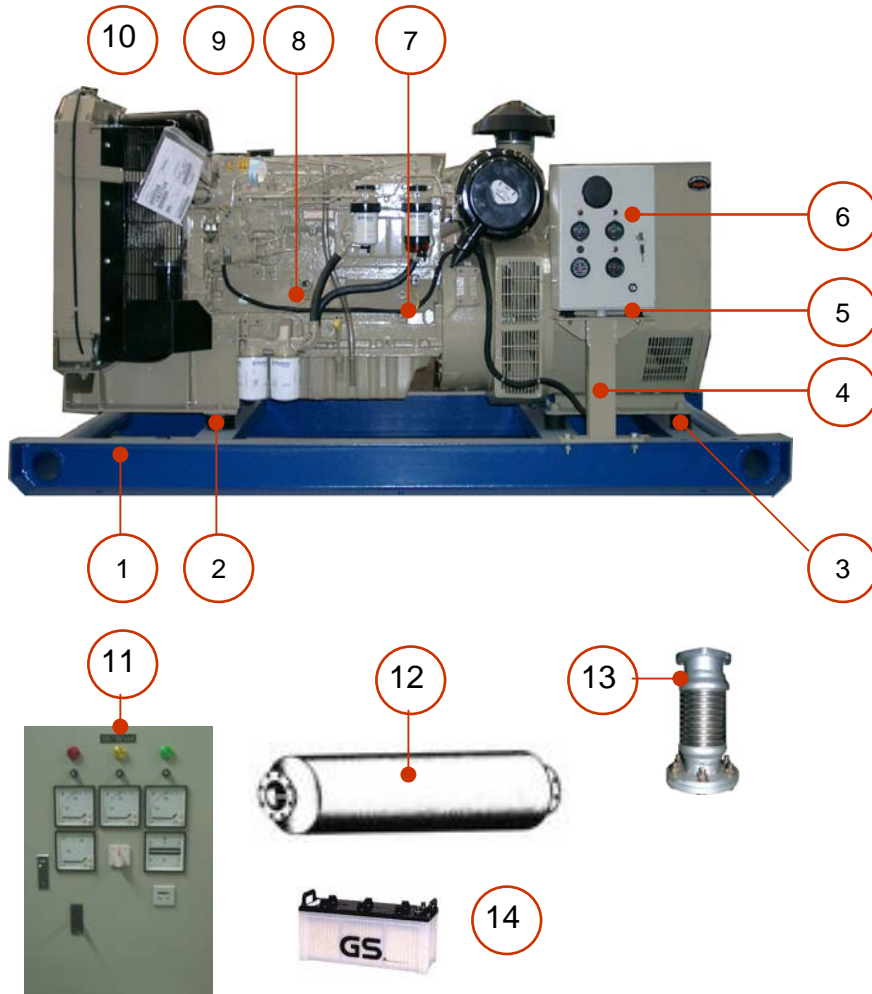

No	Part No	Part Name	Qty
1	7JH-51-10000-G	Base Frame	1
2	7JE-783-2000-A	Rubber Mounting E/G	2
3	7AG-782-1000-B	Rubber Mounting Geno	4
4	7AE-06-30001-C	Bracket Panel	1
5	7AE-06-12000	Rubber Mounting Panel	4
6	7AC-06-01200	Engine Control Panel	1
7	7AG-07-01000	Harness Loom	1
	AM-SOL	Jumper Cable LC (+)	1
	AB-MIN	Jumper Cable LC (-)	1
8	360-081-029-001	Oil Pressure Sender	1
9	323-803-001-019D	Cooling Temp. Sender	1
10	4RA003510-08	Relay Starting motor	1
11	7AI-09-13500	Wallmounted Panel	1
12	7AJ-972-1101-A	Muffler 5"	1
13	7AG-04-10000	Flexible Pipe	1
14	B-8050-0-1200	Battery N120	1
	B-8100-0-0250	Cable Battery 1000	2
	B-8018-0-0708	Terminal Battery (+) (-)	1
15	B-9014-0-1000	Tool Set	1
16	7AF-947-1000-CS	Fuel Tank 200L	1



# Perkins - Stamford Generating Set

## PL150 Panel Engine

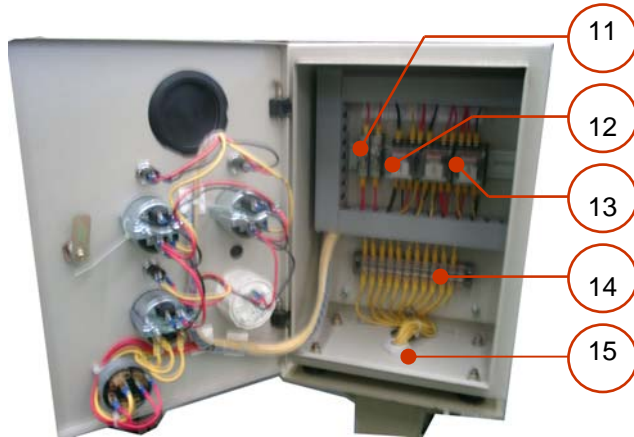
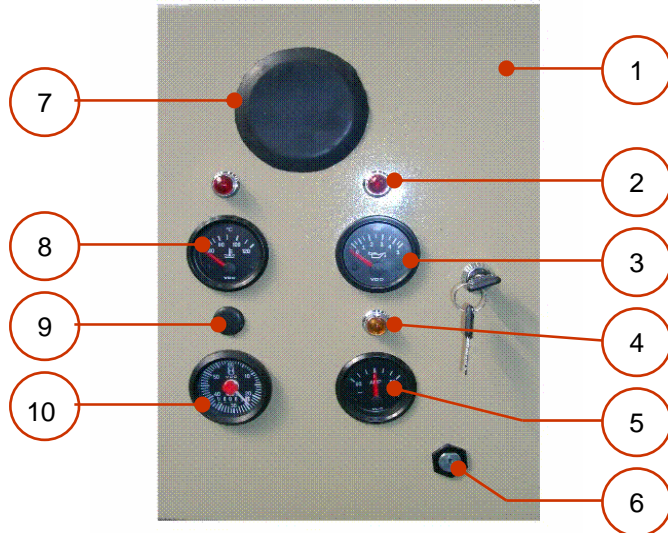

No	Part No	Part Name	Qty
1	7AJ-06-14000	Box Panel S/A	1
2	B-8116-0-0002	Case S/A Lamp, Red	2
	B-8100-1-0120	Bulb Lamp Indicator	2
3	350-030-003G	Oil Pressure Gauge	1
4	B-8116-0-0004	Case S/A Lamp, Yellow	1
	B-8100-1-0120	Bulb Lamp Indicator	1
5	190-037-002G	Ammeter Charging Gauge	1
6	2846130R	Key Starting	1
7	7AE-06-12101	Rubber Cap Tachometer	1
8	310-030-002G	Temperature Gauge	1
9	7AE-06-17000	Rubber Cap Lamp	1
10	331-810-012-002B	Hourmeter Gauge	1
11	FS10-AUS	Holder Fuse S/A	2
	F10DC	Fuse 10A DC	2
12	B-8808-0-0-0120	Relay Omron, AC	1
	PF083A	Socket Relay Omron	1
13	B-8308-0-0-0120	Relay Omron, DC	2
	PF083A	Socket Relay Omron	2
14	TB114F	Terminal Block	1
15	PG-21	Cable Gland	1

# Perkins - Stamford Generating Set

## PL200 Perkins Engine 1306-E87TAG3 Stamford UCI274H1

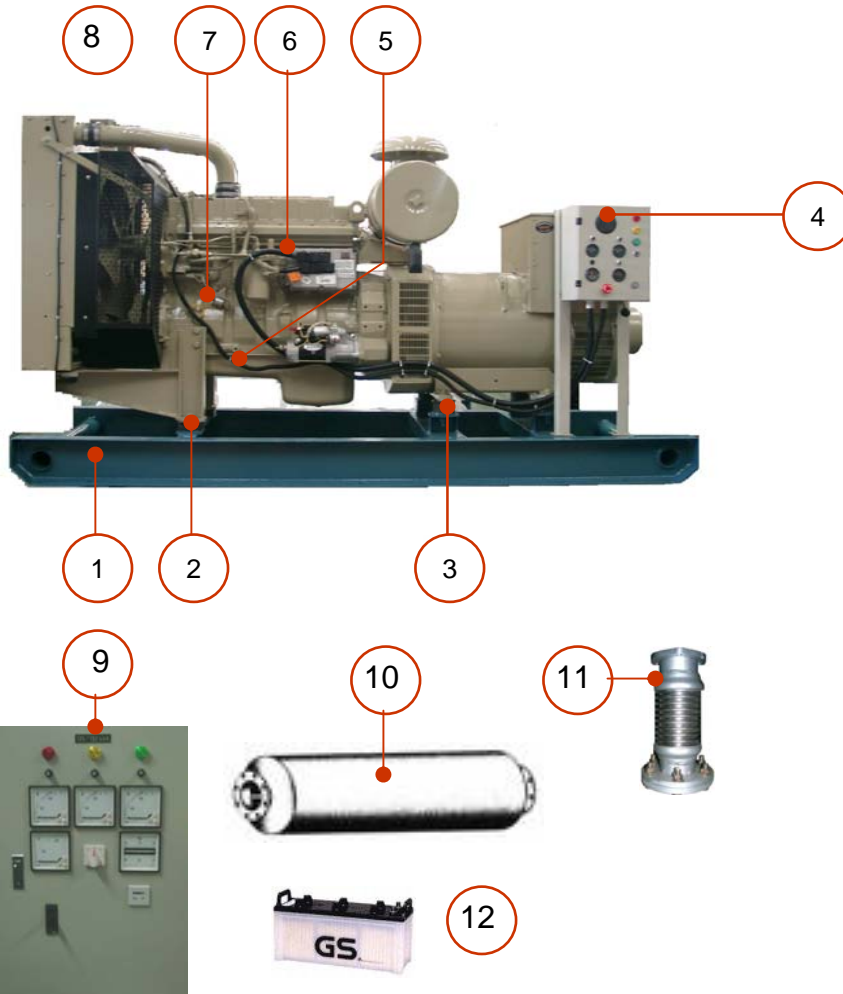

No	Part No	Part Name	Qty
1	7JJ-51-10000-D	Base Frame	1
2	7DH-783-12000	Rubber Mounting E/G	2
3	7AJ-782-3000-A	Rubber Mounting Geno	4
4	7AJ-06-01306	Engine Control Panel	1
	7AJ-06-30001	Bracket Panel	1
	7AE-06-12000	Rubber Mounting Panel	4
5	7AG-07-01000	Harness, Panel to E/G	1
6	3161C013	Harness, Panel to ECM	1
7	360-081-030-009	Oil Pressure Sender	1
8	323-803-001-019D	Cooling Temp. Sender	1
9	7AJ-09-00000	Wallmounted Panel	1
10	7AJ-972-1101-A	Muffler 5"	1
11	7AG-04-10000	Flexible Pipe	1
12	B-8050-0-1200	Battery N120	2
	B-8200-0-0250	Cable Battery 2000	2
	B-8200-0-0250	Cable Battery 500	1
	B-8018-0-0708	Terminal Battery (+) (-)	2
13	B-9014-0-2000	Tool Set	1
14	7AI-947-1000-CS	Fuel Tank 400L	1

# Perkins - Stamford Generating Set

## PL200 Panel Engine

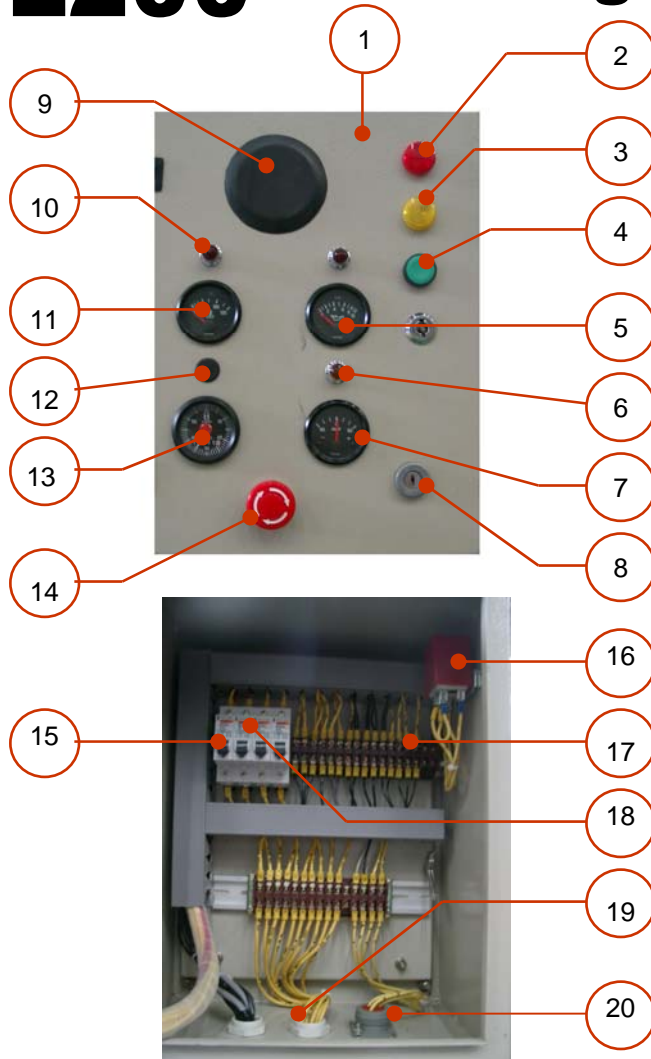

No	Part No	Part Name	Qty
1	7JU-06-10000	Box Panel S/A	1
2	B-8117-0-0005	Diagnostic Lamp, Red	1
3	B-8117-0-0007	Diagnostic Lamp, Amber	1
4	SBT-301	Diagnostic, Push Botton	1
5	350-040-004G	Oil Pressure Gauge	1
6	B-8116-0-0004	Case S/A Lamp, Yellow	1
	B-8100-1-0240	Bulb Lamp Indicator	1
7	190-037-002G	Ammeter Charging Gauge	1
8	HKT-SI-05	Key Starting	1
9	7AE-06-12101	Rubber Cap Tachometer	1
10	B-8116-0-0002	Case S/A Lamp, Red	2
	B-8100-1-0240	Bulb Lamp Indicator	2
11	310-040-002G	Temperature Gauge	1
12	7AE-06-17000	Rubber Cap Lamp	1
13	331-810-012-002B	Hourmeter Gauge	1
14	B-8317-0-0001	Emergency Stop	1
15	MCB10A1P	Breaker Power Control	2
16	2848A227	Main Power Relay	1
17	TB110TR	Terminal Block	40
18	MCB6A1P	Breaker 6A	2
19	PG-21	Cable Gland	2
20	2638C353	Diagnostic Connector	1

# Perkins - Stamford Generating Set

## PL250

Perkins Engine 1306-E87TAG6  
Stamford HCI434C1

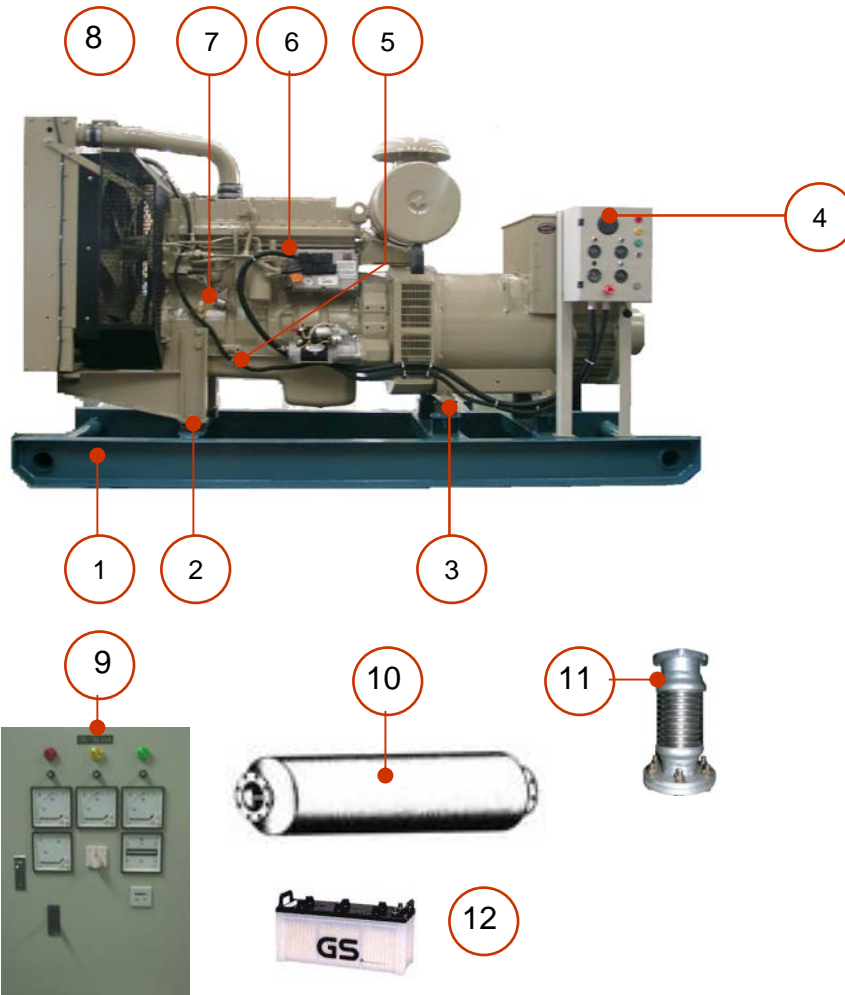

No	Part No	Part Name	Qty
1	7JK-51-10000-D	Base Frame	1
2	7DH-783-12000	Rubber Mounting E/G	2
3	7AK-782-3000-A	Rubber Mounting Geno	4
4	7AJ-06-01306	Engine Control Panel	1
	7AJ-06-30001	Bracket Panel	1
	7AE-06-12000	Rubber Mounting Panel	4
5	7AG-07-01000	Harness, Panel to E/G	1
6	3161C013	Harness, Panel to ECM	1
7	360-081-030-009	Oil Pressure Sender	1
8	323-803-001-019D	Cooling Temp. Sender	1
9	7AK-09-00000	Wallmounted Panel	1
10	7AJ-972-1101-A	Muffler 5"	1
11	7AG-04-10000	Flexible Pipe	1
12	B-8050-0-1200	Battery N120	2
	B-8200-0-0250	Cable Battery 2000	2
	B-8200-0-0250	Cable Battery 500	1
	B-8018-0-0708	Terminal Battery (+) (-)	2
13	B-9014-0-2000	Tool Set	1
14	7AI-947-1000-CS	Fuel Tank 400L	1



# Perkins - Stamford Generating Set

## PL250 Panel Engine

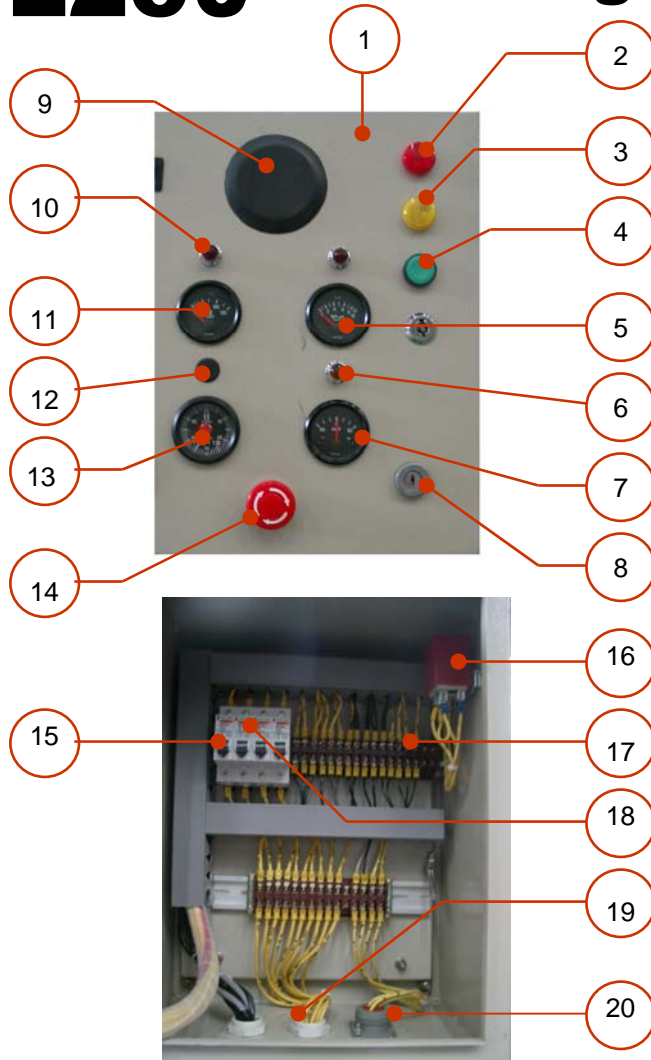

No	Part No	Part Name	Qty
1	7JU-06-10000	Box Panel S/A	1
2	B-8117-0-0005	Diagnostic Lamp, Red	1
3	B-8117-0-0007	Diagnostic Lamp, Amber	1
4	SBT-301	Diagnostic, Push Botton	1
5	350-040-004G	Oil Pressure Gauge	1
6	B-8116-0-0004	Case S/A Lamp, Yellow	1
	B-8100-1-0240	Bulb Lamp Indicator	1
7	190-037-002G	Ammeter Charging Gauge	1
8	HKT-SI-05	Key Starting	1
9	7AE-06-12101	Rubber Cap Tachometer	1
10	B-8116-0-0002	Case S/A Lamp, Red	2
	B-8100-1-0240	Bulb Lamp Indicator	2
11	310-040-002G	Temperature Gauge	1
12	7AE-06-17000	Rubber Cap Lamp	1
13	331-810-012-002B	Hourmeter Gauge	1
14	B-8317-0-0001	Emergency Stop	1
15	MCB10A1P	Breaker Power Control	2
16	2848A227	Main Power Relay	1
17	TB110TR	Terminal Block	40
18	MCB6A1P	Breaker 6A	2
19	PG-21	Cable Gland	2
20	2638C353	Diagnostic Connector	1

# Perkins - Stamford Generating Set

## PL300

Perkins Engine 2306-E14TAG1  
Stamford HCI434E1

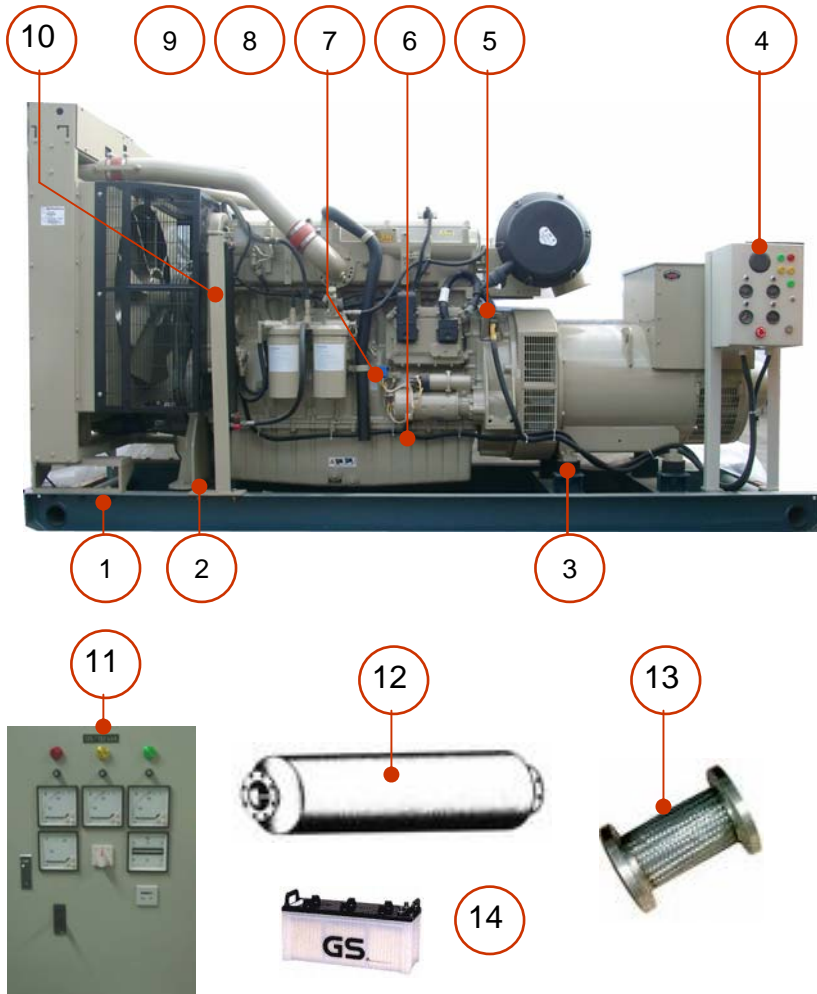

No	Part No	Part Name	Qty
1	7JM-53-10000	Base Frame	1
2	7DH-783-12000	Rubber Mounting E/G	2
3	7AK-782-3000-A	Rubber Mounting Geno	4
4	7AL-06-02306 7AJ-06-30001 7AE-06-12000	Engine Control Panel Bracket Panel Rubber Mounting Panel	1 1 4
5	7AM-07-23060-S	Harness, Panel to E/G	1
6	7AM-07-23060-ECM	Harness, Panel to ECM	1
7	SRB-632	Relay Starter Motor	
8	360-081-030-009	Oil Pressure Sender	1
9	323-803-001-019D	Cooling Temp. Sender	1
10	7JM-61-14000	Bracket Fuel Cooler	1
11	7AM-09-00000	Wallmounted Panel	1
12	7AM-972-1101-A	Muffler 6"	1
13	7AM-04-10000	Flexible Pipe	1
14	B-8050-0-1200 B-8200-0-0250 B-8200-0-0250 B-8018-0-0708	Battery N120 Cable Battery 2000 Cable Battery 500 Terminal Battery (+) (-)	2 2 1 2
15	B-9014-0-2000	Tool Set	1
16	7AL-947-1000-CS	Fuel Tank 500L	1

# Perkins - Stamford Generating Set

## PL300 Panel Engine

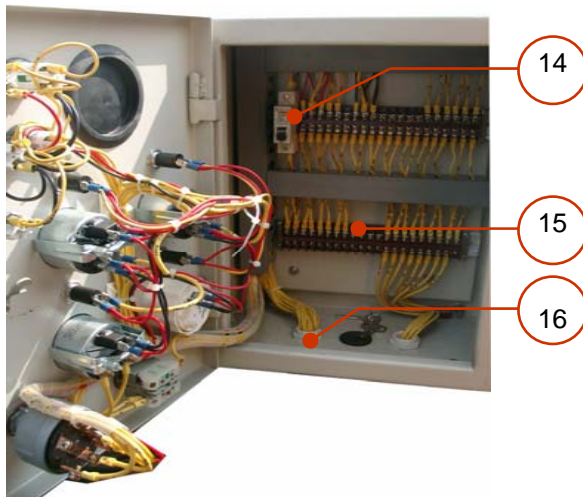
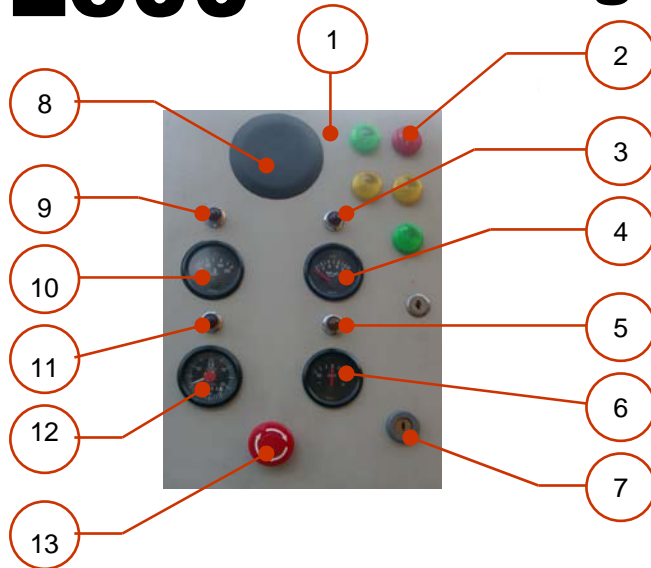

No	Part No	Part Name	Qty
1	7JM-06-10000	Box Panel S/A	1
2	B-8117-0-0005	Shutdown Indicator Lamp, Red	1
	B-8117-0-0005	Warning Indicator Lamp, Yellow	2
	B-8117-0-0005	Indicator Lamp, Green	2
	B-8100-1-0240-B	Bulb lamp, Bayonet	5
3	B-8116-0-0002	Case S/A Lamp, Red	1
	B-8100-1-0240	Bulb Lamp Indicator	1
4	350-040-004G	Oil Pressure Gauge	1
5	B-8116-0-0004	Case S/A Lamp, Yellow	1
	B-8100-1-0240	Bulb Lamp Indicator	1
6	190-037-002G	Ammeter Charging Gauge	1
7	HKT-SI-05	Key Starting	1
8	7AE-06-12101	Rubber Cap Tachometer	1
9	B-8116-0-0002	Case S/A Lamp, Red	1
	B-8100-1-0240	Bulb Lamp Indicator	1
10	310-040-002G	Temperature Gauge	1
11	B-8116-0-0002	Case S/A Lamp, Red	1
	B-8100-1-0240	Bulb Lamp Indicator	1
12	331-810-012-002B	Hourmeter Gauge	1
13	B-8317-0-0001	Emergency Stop	1
14	MCB10A1P	Breaker Power Control	1
15	TB110TR	Terminal Block	42
16	PG-21	Cable Gland	2