

2.1 SECTIONAL DRAWING

MODEL: CSE6-810VQTBH

KKS CODE

u0GMB11AP010 OILY DRAIN PIT SUMP PUMP A

u0GMB12AP010 OILY DRAIN PIT SUMP PUMP B

Note: u=5 for unit 5 and u=6 for unit 6

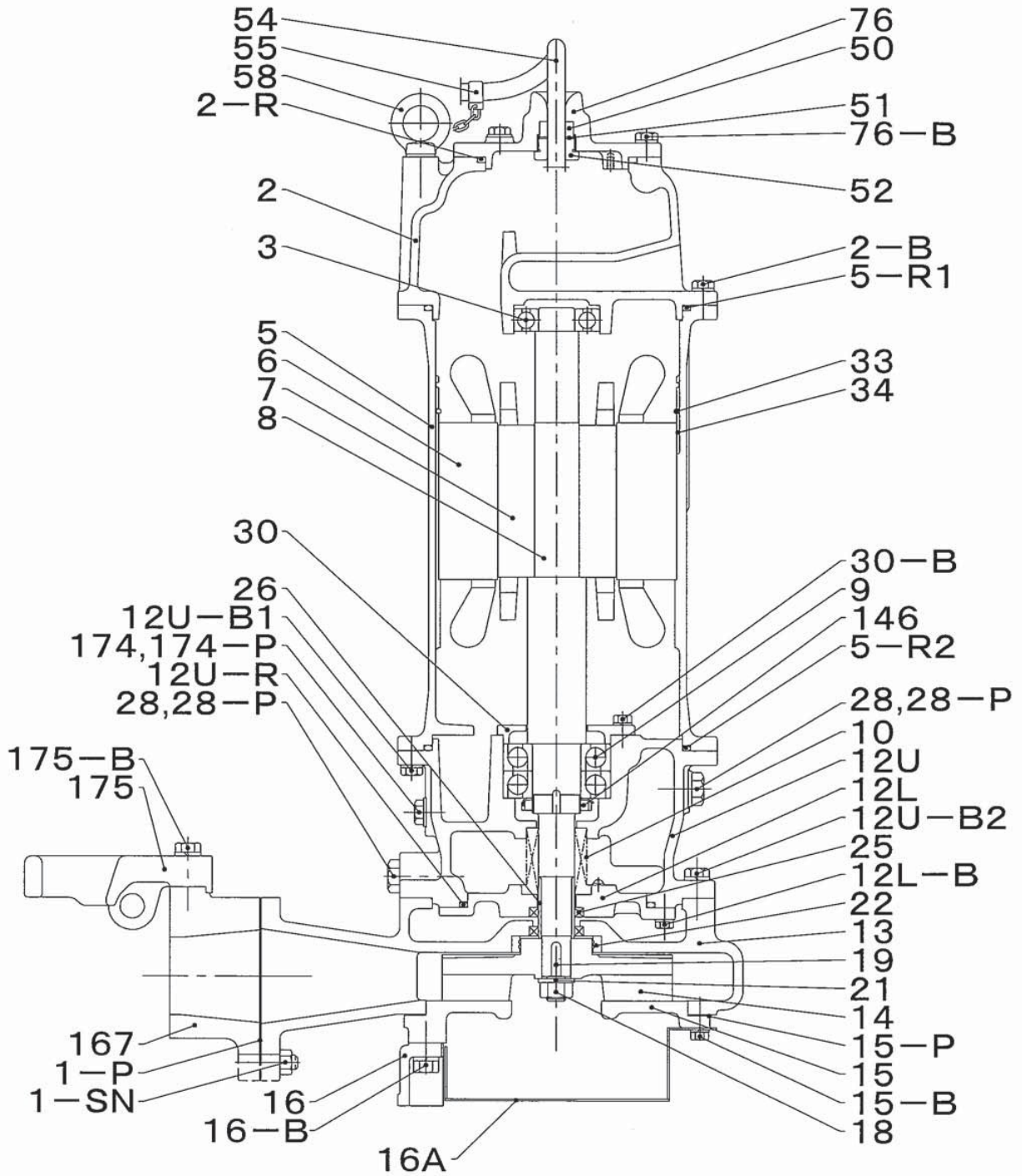

2.2 SECTIONAL DRAWING



MODEL: CSE6-810VQTBH

KKS CODE
 u0GMB11AP010 OILY DRAIN PIT SUMP PUMP A
 u0GMB12AP010 OILY DRAIN PIT SUMP PUMP B
 Note: u=5 for unit 5 and u=6 for unit 6

ITEM No.	DESCRIPTION	MATERIAL (JIS)
2	Upper Casing	SCS14
3	Upper Ball Bearing	6306ZZC3
5	Motor Housing	SCS14
6	Stator	7.5kW×2P
7	Rotor	7.5kW×2P
8	Shaft	SUS316
9	Lower Ball Bearing	7308BDB
10	Shaft Seal	Mechanical Seal
12U	Upper Oil Box	SCS14
12L	Lower Oil Box	SCS14
13	Pump Casing	SCS14
14	Impeller	SCS14
15	Suction Cover	SCS14
16	Stand	SCS14
16A	Strainer	SUS316
18	Impeller Nut	SUS316
19	Impeller Key	SUS316
21	Impeller Washer	SUS316
22	Labyrinth Seal	SUS316
25	Dust Seal	SCS14
26	Shaft Sleeve	Flu.Rubber/SUS316
28	Oil Plug	SUS316
30	Bearing Cover	SUS316
33	Stator Set Snap Ring	FC200
34	Stator Set Key	SW-B SF440
50	Cable Packing	Butyl Rubber
51	Cable Washer	Mild Steel
52	Screw Gland	Mild Steel
54	Cabletyre Cable	2P.N.C.T.
55	Cable Clamp	SUS316
58	Eyebolt	SUS316
76	Terminal Cover	SCS14
146	Bearing Nut	—
167	Coupling And Uncoupling Flange	SCS14
174	Drain Plug	SUS316
175	Shaft Holder	SCS14
1-P	Packing	Teflon
15-P	Packing	Teflon
28-P	Packing	Flu.Rubber/SUS316
174-P	Packing	Flu.Rubber/SUS316
2-R	O Ring	Flu.Rubber
5-R1	O Ring	Flu.Rubber
5-R2	O Ring	Flu.Rubber
12U-R	O Ring	Flu.Rubber
1-SN	Stud & Nut	SUS316
2-B	Bolt	SUS316
12U-B1	Bolt	SUS316
12U-B2	Bolt	SUS316
12L-B	Bolt	SUS316
15-B	Bolt	SUS316
16-B	Bolt	SUS316
30-B	Bolt	SUS316
76-B	Bolt	Mild Steel
175-B	Bolt	SUS316

NO: PL-T1180224-a

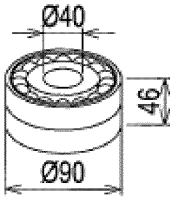
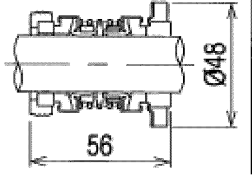
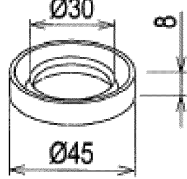
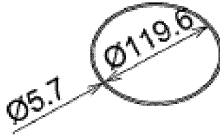
Strategic Spare Parts List (Recommended Spare Parts List)

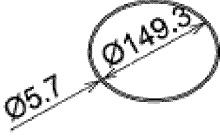
EQ/SYS.		USE		
Sump Pump		-		
No.	Description	OUTLINE	QUANTITY	REMARKS (Purpose)
TJB5-SS-MECH-SUMP-013	Lower Ball Bearing		Refer to TJB56-L1-OFF-C -00-G-LST-0021	-
TJB5-SS-MECH-SUMP-014	Shaft Seal		Refer to TJB56-L1-OFF-C -00-G-LST-0021	-
TJB5-SS-MECH-SUMP-015	Radial Oil Seal		Refer to TJB56-L1-OFF-C -00-G-LST-0021	-
TJB5-SS-MECH-SUMP-016	O ring		Refer to TJB56-L1-OFF-C -00-G-LST-0021	-
TJB5-SS-MECH-SUMP-017	O ring		Refer to TJB56-L1-OFF-C -00-G-LST-0021	-
TJB5-SS-MECH-SUMP-018	O ring		Refer to TJB56-L1-OFF-C -00-G-LST-0021	-

Strategic Spare Parts List (Recommended Spare Parts List)

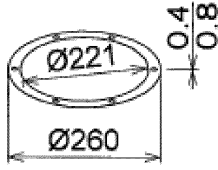
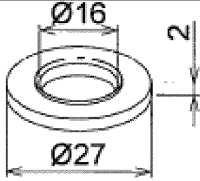
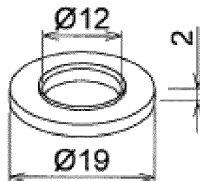
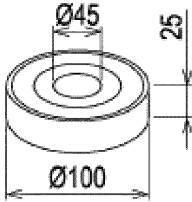
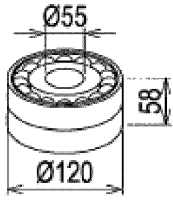
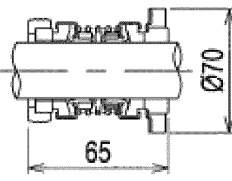
EQ/SYS.		USE		
Sump Pump		-		
No.	Description	OUTLINE	QUANTITY	REMARKS (Purpose)
TJB5-SS-MECH -SUMP-019	Packing		Refer to TJB56-L1-OFF-C -00-G-LST-0021	-
TJB5-SS-MECH -SUMP-020	Packing		Refer to TJB56-L1-OFF-C -00-G-LST-0021	-
TJB5-SS-MECH -SUMP-021	Packing		Refer to TJB56-L1-OFF-C -00-G-LST-0021	-
TJB5-SS-MECH -SUMP-022	Upper Ball Bearing		Refer to TJB56-L1-OFF-C -00-G-LST-0021	-
TJB5-SS-MECH -SUMP-023	Lower Ball Bearing		Refer to TJB56-L1-OFF-C -00-G-LST-0021	-
TJB5-SS-MECH -SUMP-024	Shaft Seal		Refer to TJB56-L1-OFF-C -00-G-LST-0021	-

