

NTN BEARING CORPORATION OF AMERICA

Head Office

1600 E. Bishop Court, P.O. Box 7604

Mount Prospect, IL 60056-7604, U.S.A.

Phone: 847-298-7500

Fax: 847-699-9744

Toll Free: 800-323-2358

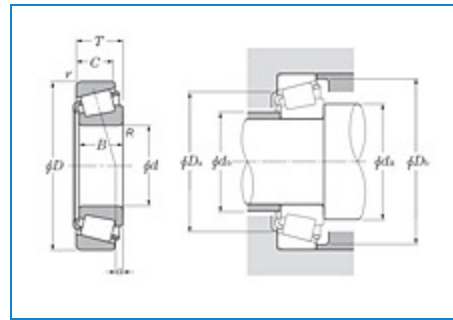
Email: mkt@ntnamerica.com
Website: www.ntnamericas.com
Item # 32316, Tapered Roller Set - Metric Series

[Order Now](#) | [Technical Specifications](#) | [Dimensional Specifications](#)
Order Now
Ordering Options

[Order Online through NTN DOL](#)
[Contact NTN Customer Relations](#)
[Search for a Licensed Distributor](#)

Technical Specifications

Type	Tapered Roller Bearing
Bore Type	Round
Material	Through Hardened Steel
Limiting Speed - Oil	3000 RPM
Limiting Speed - Grease	2300 RPM
Style	Cone & Cup

Precision Rating	Class 0
Configuration	One
Lubrication	w/o Oil Hole
e (Axial Load Factor)	0.35
Y2 (Axial Load Factor)	1.74
Y0 (Axial Load Factor)	0.96
Static Load Rating	118000 lbf 525000 N 525.00 kN
Dynamic Load Rating	89000 lbf 395000 N 395.00 kN
Enclosure	Open
Weight	14.132 lb 6.410 kg
Operating Temperature Range	-40 to 250 °F -40 to 120 °C

Dimensional Specifications

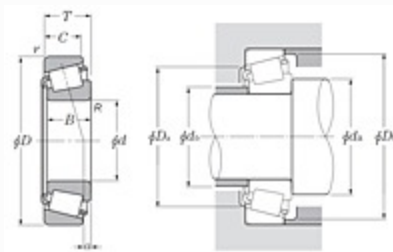

Tapered Roller Set - Metric Series - Dimensions

d	3.1496 in 80.000 mm
D	6.6929 in 170.000 mm
C	1.8898 in 48.000 mm

B	2.2835 in 58.000 mm
a (Effective Load Center)	-0.7874 in -20.000 mm
T	2.4213 in 61.500 mm
r	0.0800 in 2.000 mm
R	0.10 in 2.5 mm
da	3.70 in 94.0 mm
db	3.86 in 98.0 mm
Da	6.22 in 158.0 mm
Da min	5.59 in 142.0 mm
Db	6.26 in 159.0 mm