

NTN BEARING CORPORATION OF AMERICA

Head Office

1600 E. Bishop Court, P.O. Box 7604

Mount Prospect, IL 60056-7604, U.S.A.

Phone: 847-298-7500

Fax: 847-699-9744

Toll Free: 800-323-2358

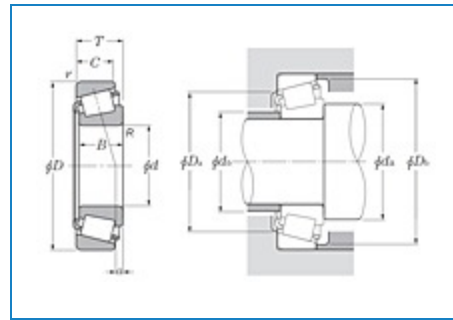
Email: mkt@ntnamerica.com
Website: www.ntnamericas.com
Item # 30226, Tapered Roller Set - Metric Series

[Order Now](#) | [Technical Specifications](#) | [Dimensional Specifications](#)
Order Now
Ordering Options

[Order Online through NTN DOL](#)
[Contact NTN Customer Relations](#)
[Search for a Licensed Distributor](#)

Technical Specifications

Type	Tapered Roller Bearing
Bore Type	Round
Material	Through Hardened Steel
Limiting Speed - Oil	2000 RPM
Limiting Speed - Grease	1500 RPM
Style	Cone & Cup

Precision Rating	Class 0
Configuration	One
Lubrication	w/o Oil Hole
e (Axial Load Factor)	0.44
Y2 (Axial Load Factor)	1.38
Y0 (Axial Load Factor)	0.76
Static Load Rating	114000 lbf 505000 N 505.00 kN
Dynamic Load Rating	84500 lbf 375000 N 375.00 kN
Enclosure	Open
Weight	15.983 lb 7.250 kg
Operating Temperature Range	-40 to 250 °F -40 to 120 °C

Dimensional Specifications

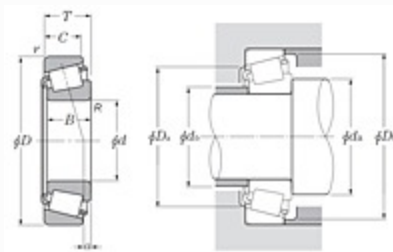

Tapered Roller Set - Metric Series - Dimensions

d	5.1181 in 130.000 mm
D	9.0551 in 230.000 mm
C	1.3386 in 34.000 mm

B	1.5748 in 40.000 mm
a (Effective Load Center)	-0.0689 in -1.750 mm
T	1.7224 in 43.750 mm
r	0.0800 in 2.000 mm
R	0.08 in 2.0 mm
da	5.83 in 148.0 mm
db	5.98 in 152.0 mm
Da	8.50 in 216.0 mm
Da min	7.99 in 203.0 mm
Db	8.58 in 218.0 mm