

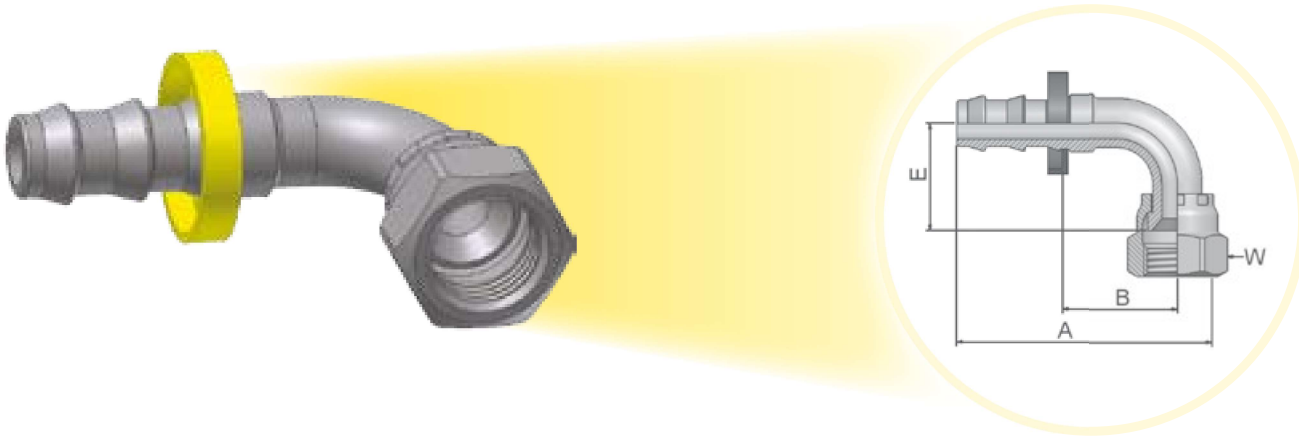



39/3W – Female JIC 37° / SAE 45° – Dual Flare – Swivel Female 90° Elbow

ISO 12151-5-SWES – DKJ 90°

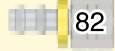

Approved fitting series for hose types:

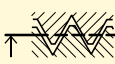

XXXX-XX-XX Part Number 	 Hose I.D.				 Thread UNF	A	B	E	 W
	DN	Inch	Size	mm					
33982-4-4	6	1/4	-4	6,3	7/16x20	39	20	17	5/8
33W82-4-4C-SM	6	1/4	-4	6,3	7/16x20	39	20	21	17
33982-6-6	10	3/8	-6	9,5	9/16x18	50	28	22	11/16
33982-6-6-SM	10	3/8	-6	9,5	9/16x18	47	25	23	19
33982-6-6C-SM	10	3/8	-6	9,5	9/16x18	47	25	23	19
33982-8-8	12	1/2	-8	12,7	3/4x16	59	33	28	7/8
33W82-8-8-SM	12	1/2	-8	12,7	3/4x16	55	29	28	22
33982-10-10	16	5/8	-10	15,9	7/8x14	74	37	31	1
33982-12-12	20	3/4	-12	19,1	1-1/16x12	84	46	46	1-1/4
33982-12-12-SM	20	3/4	-12	19,1	1-1/16x12	83	46	48	32

Material: Steel chromium(VI)-free plated
C: Material: Stainless Steel
SM: Metric Hexagon

39/3W – Female JIC 37° / SAE 45° – Dual Flare – Swivel Female 90° Elbow

ISO 12151-5-SWES – DKJ 90°

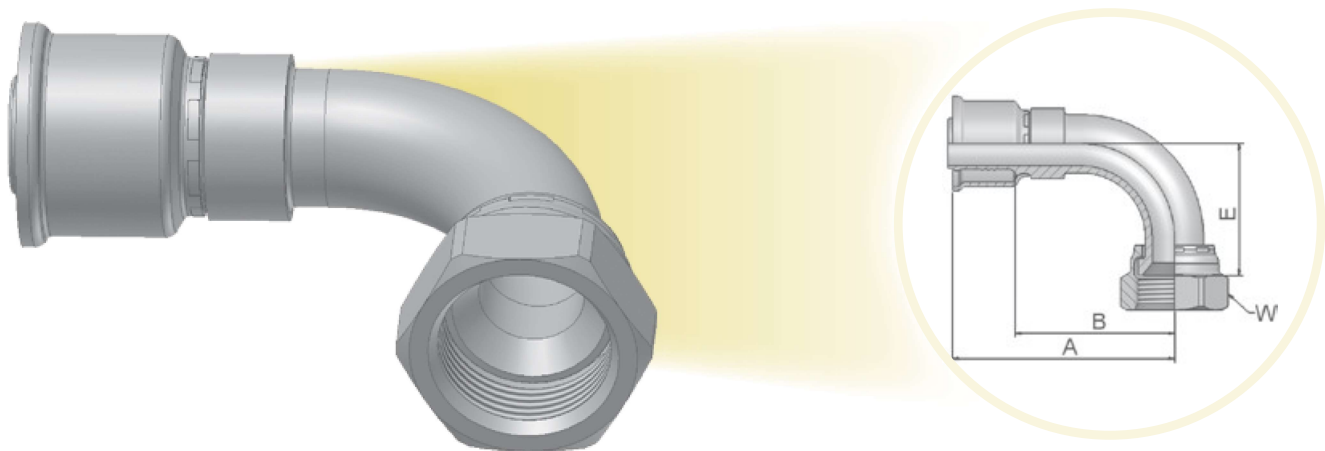

Approved fitting series for hose types:



XXXX-XX-XX Part Number  26	Hose I.D.			Thread UNF	Tube size	A	B	E	W
	Inch	Size	mm						
13W26-4-4-SM	3/16	-4	5,0	7/16x20	1/4	45	20	21	14
13W26-5-5-SM	1/4	-5	6,3	1/2x20	5/16	50	30	20	17
13926-6-6-SM	5/16	-6	8,0	9/16x18	3/8	49	29	22	19
13926-6-6	5/16	-6	8,0	9/16x18	3/8	51	28	22	11/16
13W26-8-6-SM	5/16	-6	8,0	3/4x16	3/8	52	32	29	22
13W26-8-8-SM	13/32	-8	10,0	3/4x16	1/2	53	32	29	22
13W26-8-8	13/32	-8	10,0	3/4x16	1/2	54	32	29	7/8
13W26-8-10-SM	1/2	-10	12,5	3/4x16	5/8	56	34	29	22
13W26-10-10-SM	1/2	-10	12,5	7/8x14	5/8	60	38	32	27
13W26-10-10	1/2	-10	12,5	7/8x14	5/8	65	41	31	1
13W26-10-12-SM	5/8	-12	16,0	7/8x14	5/8	63	41	33	27
13926-12-12-SM	5/8	-12	16,0	1-1/16x12	3/4	73	51	46	32
13926-12-12	5/8	-12	16,0	1-1/16x12	3/4	74	51	46	1-1/4
13926-16-16-SM	7/8	-16	22,0	1-5/16x12	1	102	75	59	41
13926-20-20-SM	1-1/8	-20	29,0	1-5/8x12	1-1/4	108	81	70	50

Material: steel chromium(VI) free plated
SM: Metric Hexagon

39/3W – Female JIC 37° / SAE 45° – Dual Flare – Swivel Female 90° Elbow

ISO 12151-5-SWES – DKJ 90°

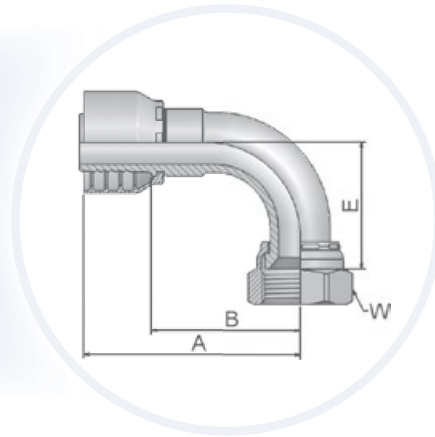
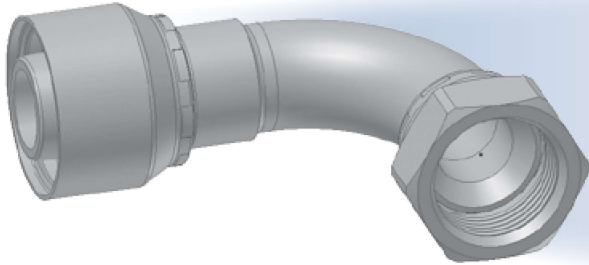

Approved fitting series for hose types:



XXXX-XX-XX Part Number		Hose I.D.				Thread UNF	A	B	E	W
46	48	DN	Inch	Size	mm		mm	mm	mm	mm
13W46-4-4	13W48-4-4	6	1/4	-4	6,3	7/16x20	48	24	21	17
13W46-5-4	13W48-5-4	6	1/4	-4	6,3	1/2x20	58	34	21	17
13946-6-4	13948-6-4	6	1/4	-4	6,3	9/16x18	51	27	23	19
13W46-5-5	13W48-5-5	8	5/16	-5	7,9	1/2x20	49	25	21	17
13946-6-5	13948-6-5	8	5/16	-5	7,9	9/16x18	51	28	23	19
13W46-4-6	13W48-4-6	10	3/8	-6	9,5	7/16x20	46	23	21	17
13946-6-6	13948-6-6	10	3/8	-6	9,5	9/16x18	51	28	23	19
13W46-8-6	13W48-8-6	10	3/8	-6	9,5	3/4x16	59	36	29	22
13W46-10-6	13W48-10-6	10	3/8	-6	9,5	7/8x14	61	38	32	27
13946-6-8	13948-6-8	12	1/2	-8	12,7	9/16x18	54	30	23	19
13W46-8-8	13W48-8-8	12	1/2	-8	12,7	3/4x16	55	31	29	22
13W46-10-8	13W48-10-8	12	1/2	-8	12,7	7/8x14	63	39	32	27
13946-12-8	13948-12-8	12	1/2	-8	12,7	1-1/16x12	73	49	48	32
13W46-10-10	13W48-10-10	16	5/8	-10	15,9	7/8x14	64	39	33	27
13946-12-10	13948-12-10	16	5/8	-10	15,9	1-1/16x12	75	49	48	32
13946-12-12	13948-12-12	20	3/4	-12	19,1	1-1/16x12	80	54	48	32
13946-14-12	13948-14-12	20	3/4	-12	19,1	1-3/16x12	80	54	51	36
13946-16-12	13948-16-12	20	3/4	-12	19,1	1-5/16x12	80	54	56	41
13946-12-16	13948-12-16	25	1	-16	25,4	1-1/16x12	88	58	48	32
13946-16-16	13948-16-16	25	1	-16	25,4	1-5/16x12	98	68	56	41
13946-20-16	13948-20-16	25	1	-16	25,4	1-5/8x12	98	68	62	50
13946-20-20		32	1-1/4	-20	31,8	1-5/8x12	124	86	70	50
	13948-20-20	32	1-1/4	-20	31,8	1-5/8x12	130	83	70	50
	13948-24-20°	32	1-1/4	-20	31,8	1-7/8x12	130	82	80	60
	13948-24-24	40	1-1/2	-24	38,1	1-7/8x12	140	102	84	60
	13948-32-32	50	2	-32	50,8	2-1/2x12	200	152	152	75

°Assembly only with Parkrimp 2 machine
Material: steel chromium(VI) free plated



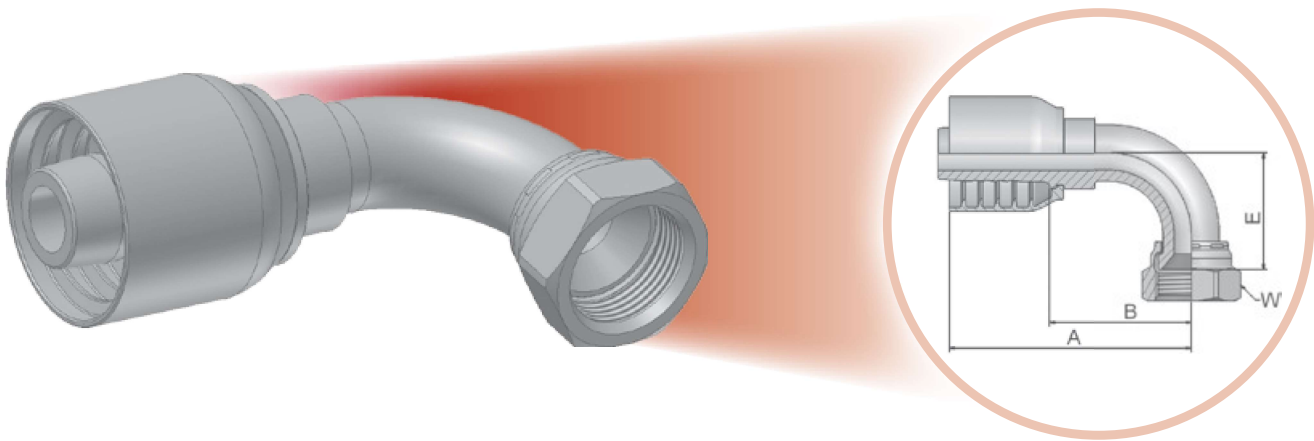

39/3W – Female JIC 37° / SAE 45° – Dual Flare – Swivel Female 90° Elbow

ISO 12151-5-SWES – DKJ 90°



Approved fitting series for hose types:



XXXX-XX-XX Part Number 	 Hose I.D.				 Thread UNF	A	B	E	 W
	DN	Inch	Size	mm					
13970-6-6-SM	10	3/8	-6	9,5	9/16x18	58	29	22	19
13W70-8-6-SM*	10	3/8	-6	9,5	3/4x16	64	35	28	22
13970-6-8-SM	12	1/2	-8	12,7	9/16x18	64	29	22	19
13970-8-8-SM*	12	1/2	-8	12,7	3/4x16	68	33	28	22
13970-10-8-SM*	12	1/2	-8	12,7	7/8x14	74	39	32	27
13970-12-8-SM	12	1/2	-8	12,7	1-1/16x12	83	48	47	32
13970-8-10-SM*	16	5/8	-10	15,9	3/4x16	74	34	28	22
13970-10-10-SM*	16	5/8	-10	15,9	7/8x14	80	41	33	27
13970-12-10-SM	16	5/8	-10	15,9	1-1/16x12	86	48	47	32
13970-12-12-SM	20	3/4	-12	19,1	1-1/16x12	89	50	48	32
13970-16-12-SM	20	3/4	-12	19,1	1-5/16x12	89	50	51	41
13970-12-16-SM	25	1	-16	25,4	1-1/16x12	101	54	46	32
13970-16-16-SM	25	1	-16	25,4	1-5/16x12	111	64	55	41
13970-20-16-SM	25	1	-16	25,4	1-5/8x12	109	64	62	50
13970-20-20-SM	32	1-1/4	-20	31,8	1-5/8x12	130	83	70	50
13970-24-20-SM	32	1-1/4	-20	31,8	1-7/8x12	130	82	80	60
13970-24-24-SM	40	1-1/2	-24	38,1	1-7/8x12	156	101	101	60

* These fittings contain a dual seat that accepts both JIC (37°) and SAE (45°) male configurations. The other sizes accept the JIC (37°) male configurations only.

Material: steel chromium(VI) free plated
SM: Metric Hexagon



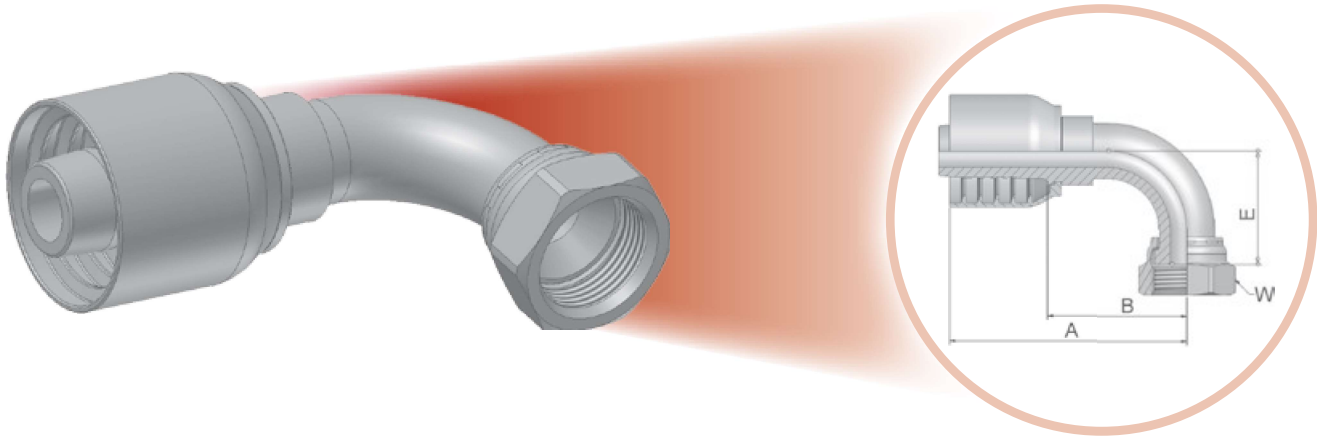

39/3W – Female JIC 37° / SAE 45° – Dual Flare – Swivel Female 90° Elbow

ISO 12151-5-SWES – DKJ 90°



Approved fitting series for hose types:



XXXX.XX.XX Part Number 	 Hose I.D.				 Thread UNF	A	B	E	 W
	DN	Inch	Size	mm					
13971-6-6-SM	10	3/8	-6	9,5	9/16x18	58	29	22	19
13971-6-8-SM	12	1/2	-8	12,7	9/16x18	64	29	22	19
13971-8-8-SM*	12	1/2	-8	12,7	3/4x16	68	33	28	22
13971-10-8-SM*	12	1/2	-8	12,7	7/8x14	74	39	32	27
13971-10-10-SM*	16	5/8	-10	15,9	7/8x14	80	41	33	27
13971-12-12-SM	20	3/4	-12	19,1	1-1/16x12	89	50	48	32
13971-16-12-SM	20	3/4	-12	19,1	1-5/16x12	89	50	51	41
13971-12-16-SM	25	1	-16	25,4	1-1/16x12	99	54	46	32
13971-16-16-SM	25	1	-16	25,4	1-5/16x12	109	64	55	41
13971-20-16-SM	25	1	-16	25,4	1-5/8x12	109	64	62	50
13971-20-20-SM	32	1-1/4	-20	31,8	1-5/8x12	130	83	70	50
13971-24-20-SM°	32	1-1/4	-20	31,8	1-7/8x12	130	82	80	60
13971-24-24-SM	40	1-1/2	-24	38,1	1-7/8x12	161	101	101	60

° Assembly on Parkrimp® 2 machine only.

* These fittings contain a dual seat that accepts both JIC (37°) and SAE (45°) male configurations.

The other sizes accept the JIC (37°) male configurations only.

Material: steel chromium(VI) free plated

SM: Metric Hexagon



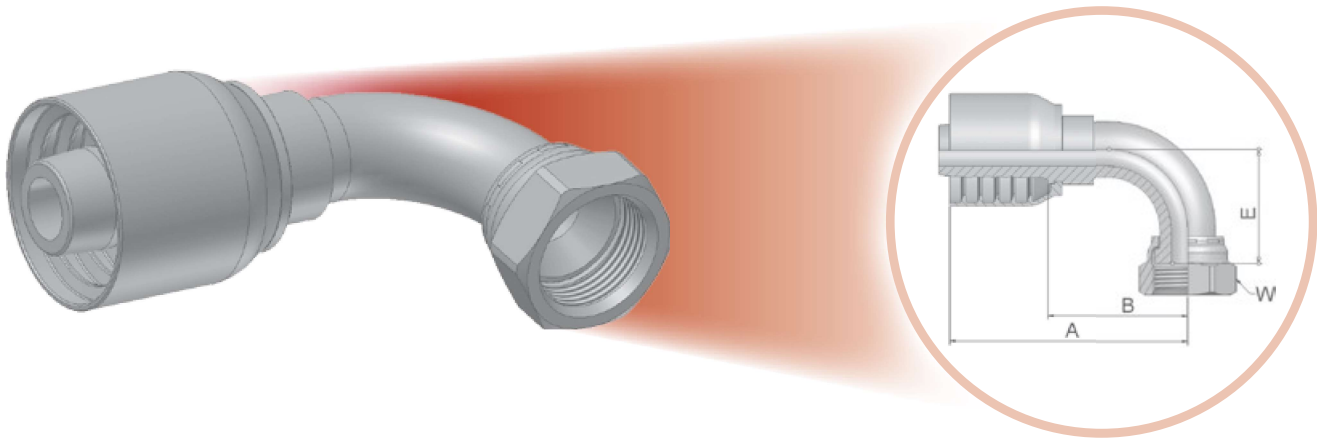

39 – Female JIC 37° – Swivel – 90° Elbow

ISO 12151-5-SWES – DKJ 90°



Approved fitting series for hose types:



XXXX.XX.XX Part Number 	 Hose I.D.				 Thread UNF	A	B	E	 W
	DN	Inch	Size	mm					
13973-12-12	20	3/4	-12	19,1	1-1/16x12	103	59	62	1-1/2
13973-16-12	20	3/4	-12	19,1	1-5/16x12	115	94	41	1-1/2
13973-16-16-SM	25	1	-16	25,4	1-5/16x12	118	67	56	41
13973-20-20-SM	32	1.1/4	-20	31,8	1-5/8x12	151	87	85	55
13973-24-24-SM	40	1-1/2	-24	38,1	1-7/8x12	194	119	102	60
13973-32-32-SM	50	2	-32	50,8	2-1/2x12	229	157	152	75

Material: steel chromium(VI) free plated
SM: Metric Hexagon



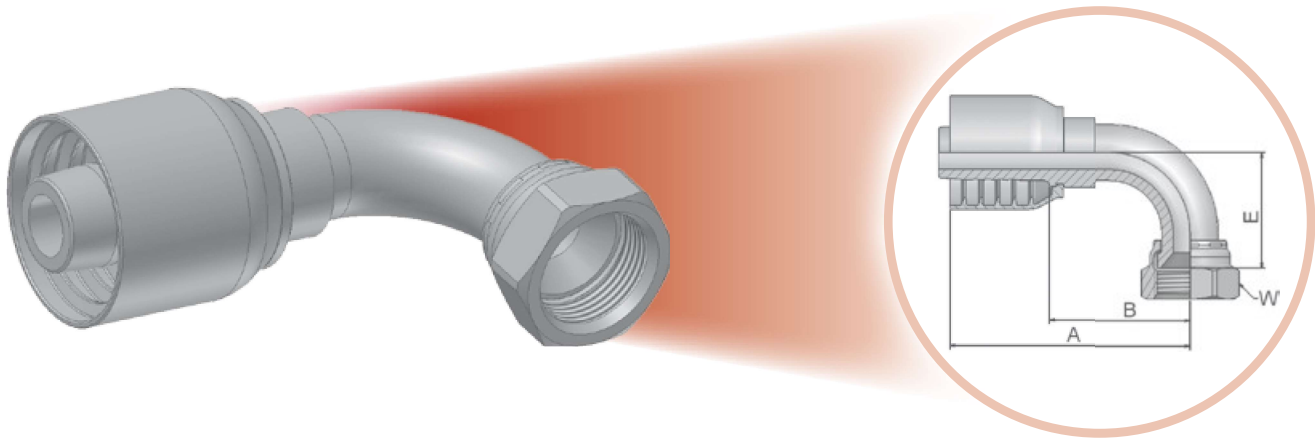

39 – Female JIC 37° – Swivel – 90° Elbow

ISO 12151-5-SWES – DKJ 90°



Approved fitting series for hose types:



XXXX.XX.XX Part Number 	 Hose I.D.				 Thread UNF	A mm	B mm	E mm	 H mm / Inch
	DN	Inch	Size	mm					
13978-12-12	20	3/4	-12	19,1	1-1/16x12	103	59	62	1-1/2
13978-16-16	25	1	-16	25,4	1-5/16x12	118	70	74	1-1/2
13978-20-20-SM	32	1.1/4	-20	31,8	1-5/8x12	151	87	85	55
13978-24-24	40	1-1/2	-24	38,1	1-7/8x12	180	122	102	2-1/4

Material: steel chromium(VI) free plated
SM: Metric Hexagon