

+ MARKING METHODS

123
M1 SINGLE CHARACTER MARKERS

Consists of single character markers that can be combined with each other to give total marking flexibility.

123
M2 MULTI CHARACTER MARKERS

Allows you to order markers already printed with the complete information in accordance with your specification.

123
M3 ON-SITE

Allows you to produce your own markers on site with one of Partex marking machines.

+ PACKAGING

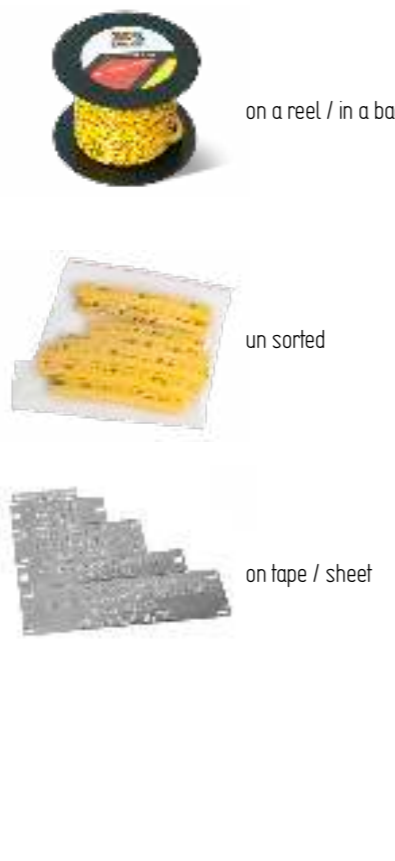

PA-10003BV40.1













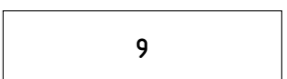

- 1. Product series**
PA = PA profile
PO = PO profile
PK = PK profile
- 2. Variations**
Z = Zerex / Halogen free
- = Standard version
+ = An improved product
- 3. Size**
- 4. Length**
- 5. Packaging**
A = Cut / loose markers in a bag
B = Semi cut markers on reel
P = Semi cut markers in strips in bags
S = Semi cut markers on compact disc
- 6. Type of print**
B = Black ink jet print
V = Hot stamped print
N = Neutral / Blank markers
- 7. Colour of profile**
Colours according to the international colour code
- 8. Colour of print**
Print colour according to the international colour code.
Some products can only be printed in black or white.
- 9. Type of characters**
A-Z Letters
0-9 Numbers
Special characters such as: + - / earth sign etc.

INTERNATIONAL COLOUR CODE

We offer several types of printing. For example, single-character markers are hot stamped and multi-character markers are printed with ink or thermal transfer.

The colours of our markers are consistent with international colour code shown below.

 0	black marker (RAL9011) white print	 7	violet marker (RAL4006) white print
 1	brown marker (RAL8015) white print	 8	grey marker (RAL7005) black print
 2	red marker (RAL3018) white print	 9	white marker (RAL9010) black print
 3	orange marker (RAL2004) black print		yellow-green marker black print
 4	yellow marker (RAL1021) black print		red marker, white print
 5	green marker (RAL6001) white print		blue marker, white print
 6	blue marker (RAL5010) white print		



PY
Single character closed markers for wires with small diameters.

▶ page 14



PA/PAZ
Single character closed markers. Chevron Cut.

▶ page 14



PZ
Single character closed markers. Straight Cut.

▶ page 16



PC
Single character open markers.

▶ page 18



PCA
Single-character open marker.

▶ page 20



PK+
Single-character markers mounted on wires.

▶ page 22



PA+/PC/PK+
Multi-character marking
Markers printed according to customer requirements.

▶ page 26



PO/POZ
Multi-character marking
Oval profile for marking wire and cable (POZ - Halogen-free).

▶ page 28



PHZ
Multi-character marking
Heat-shrink tubing for thermal transfer printers.

▶ page 32



PHZF
Multi-character marking
Flat, halogen free heat shrink for thermal transfer printers.

▶ page 34



SG/MS/HF/NF/EF/ET
ProSleeve ladder format printable heat-shrink tubing.

▶ page 36-46



PT+
PA type sleeve with oval, transparent pocket for marker tags.

▶ page 48



PTZ+
Multi-character marking
Halogen free, PA type sleeve with oval, transparent pocket for marker tags.

▶ page 48



PTC
Multi-character marking
PC type sleeve with oval, transparent pocket for marker tags.

▶ page 50



PM
Transparent holder for cable marking. Mounted with cable ties.

▶ page 52



PTM
Transparent holder for cable marking. Mounted with cable ties.

▶ page 54



PK+
Single-character markers mounted on PDH or PKH carriers.

▶ page 22



PPQ
Flat and flexible cable marker.

▶ page 56



TIE/TAG
Write-on identification tags.

▶ page 70



PO/POZ
Multi-character marking
Oval profile for marking wire and cable (POZ - Halogen-free).

▶ page 28



PHZ
Multi-character marking
Heat-shrink tubing for thermal transfer printers.

▶ page 32



PHZF
Multi-character marking
Flat, halogen free heat shrink for thermal transfer printers.

▶ page 34



CMZ/CMM/CMD/CML/CMT
ProSleeve ladder format printable cable markers.

▶ page 58-62



SG/MS/HF/NF/EF/ET
ProSleeve ladder format printable heat-shrink tubing.

▶ page 36-46



PKS - single character
Stainless steel single-character markers mounted on a metal holder.

▶ page 64



PKS - Multi-character
Multi-character markers embossed according to specification, with up to four lines of text.

▶ page 66



PKS
Stainless steel markers laser etched with specified text or symbols.

▶ page 68



PFC
Printable marker cards, made from halogen free material.

▶ page 85





PROMARK-T1000
Professional and portable thermal transfer printer for the production of markers.

▶ page 100



EOS1
A compact thermal transfer printer suitable for printing onto PPG cable markers.

▶ page 104



MK10
Thermal transfer industrial printer to print markers

▶ page 106



MK10-DH
Thermal transfer industrial printer to print double-sided markers

▶ page 108



PRIMACY
Thermal transfer printer specifically designed for PFC cards.

▶ page 112



RIBBONS
Thermal transfer ribbons for use in the EOS1, MK10 and MK10-DH printers

▶ page 81



WinSign
Software for controlling Parlex marking machines

▶ page 114



HFC
Halogen-free cable ties made from Nylon 6.6.

▶ page 95



HFC-UV
Cable Ties for outdoor use

▶ page 96



MAR
Cable ties for marking

▶ page 97



TT1
Automatic tool for nylon cable ties

▶ page 97



SST
Stainless steel cable ties

▶ page 98



SSTC
Coated cable ties Cable ties in stainless steel, coated with a layer of polyester

▶ page 99



SSTM
Mounts for Stainless steel cable ties

▶ page 97



SSTG/SSAT
Tensioning tools for stainless steel cable ties

▶ page 97



TIE PEN
Pen for manual marking of markers

▶ page 71



SP
Spiral tube

▶ page 94



PE-P
Plates engraved with a two-layer plastic laminate

▶ page 72



SSDT
Stainless steel dog tags laser engraved

▶ page 73



SL/CL
Warning, Danger and PAT test labels

▶ page 74



EPL/EPF
ProSleeve ladder format printable panel labels

▶ page 80



PS - Component markers
Universal markers for marking modular and electrical components

▶ page 82



PP+
Flat profile for insertion into marker carriers or mounted terminal blocks

▶ page 84



PPA+
Self-adhesive flat profile for component marking

▶ page 84



PROMARK-PL
Self-adhesive labelling tape

▶ page 103



CAS
Cassettes to store single-character markers PA.

▶ page 86



MD/MDH
Holder and applicators for single marker PA.

▶ page 87



PLD
Self-adhesive wrap around markers

▶ page 88



PUJ/MD10
Applicators for easy assembly of single character markers

▶ page 89



PAL/B
Box for storage of single-character markers

▶ page 90



PAL/50
Box for storage of single-character markers

▶ page 91



SRC-T
Cardboard marker dispenser

▶ page 92



SRP
Heavy duty, steel marker dispenser

▶ page 93



+ INFORMATION

- + Closed, permanent grip and adjustable marker sleeves
- + For applications including electrical engineering, pneumatics and hydraulics
- + Twist-protection for secure combination marking
- + Excellent legibility

+ PROPERTIES

Temperature range

PA: -30°C to +60°C

PAZ: -30°C to +90°C

Material

PA: PVC

PAZ: ZEREX (Halogen free)

Print

hot stamped

Standard colours

PA: yellow and white

international colour code for 0-9

PAZ: yellow and white

Text

0-9, A-Z, + - / : ~ ↓



+ DIMENSIONS

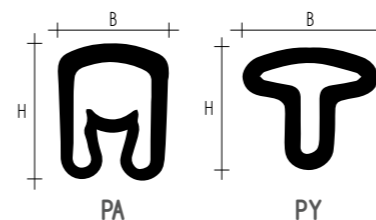

TYPE	HEIGHT (H mm)	WIDTH (B mm)	TEXT HEIGHT (mm)
PY-01	33	35	26
PA-02	36	35	26
PA-1	55	4.2	26
PA-2	9.5	6.6	4.0
PA-3	16.5	11.0	4.0

+ SIZES AND PACKAGING

TYPE	DIAMETER / AREA*	LENGTH	NUMBER OF CHARACTERS	PACKAGING
PY-01	~10 - 2.0 mm ~0.2 - 0.7 mm ²	3 mm	1	bag of 5x200 pcs - cut roll of 1000 pcs
PA-02/PAZ02	~13 - 3.0 mm 0.5 to 0.75 mm ²	3 mm	1	bag of 5x200 pcs - cut bag of 250 pcs - strips roll of 1000 pcs disc of 500 pcs
PA-1/PAZ1	~25 - 5.0 mm 0.75 to 4.0 mm ²	3 mm	1	bag of 5x200 pcs - cut bag of 250 pcs - strips roll of 1000 pcs disc of 500 pcs
PA-2/PAZ2	~4.0 - 10.0 mm 2.5 to 10.0 mm ²	4 mm	1	bag of 5x100 pcs - cut bag of 250 pcs - strips disc of 250 pcs
PA-3/PAZ3	~8.0 - 16.0 mm 16.0 to 50.0 mm ²	6 mm	1	bag of 5x20 pcs - cut

* Size shown refers to BS6231 tri-rated cable.

+ RELATED PRODUCTS



MD/MDH
PAGE 87



CAS
PAGE 86



PUJ/MD10
PAGE 89

+ APPLICATION

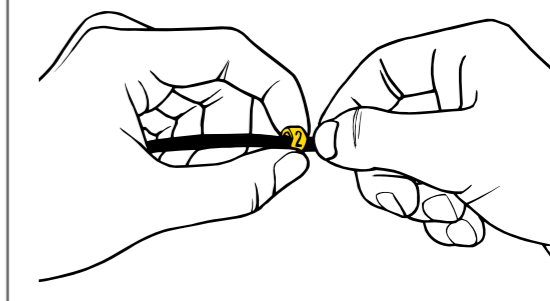



+ INFORMATION

- + Closed, permanent grip and adjustable marking sleeves
- + For applications including electrical engineering, pneumatics and hydraulics
- + Twist-protection for secure combination marking
- + Excellent legibility

+ PROPERTIES

Temperature range
-30°C to +60°C

Material
PVC

Print
hot stamped

Standard colours
yellow and white
international colour code for 0-9

Text
0-9, A-Z, + - / : ~ ⊥



+ DIMENSIONS

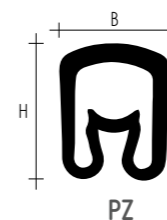

TYPE	HEIGHT (H mm)	WIDTH (B mm)	TEXT HEIGHT (mm)
PZ-02	3.6	3.5	2.6
PZ-1	5.5	4.2	2.6
PZ-2	9.5	6.6	4.0

+ SIZES AND PACKAGING

TYPE	DIAMETER / AREA*	LENGTH	NUMBER OF CHARACTERS	PACKAGING
PZ-02	~1.3 - 3.0 mm 0.5 to 0.75 mm ²	3 mm	1	bag of 5x200 pcs - cut bag of 250 pcs - strips
PZ-1	~2.5 - 5.0 mm 0.75 to 4.0 mm ²	3 mm	1	bag of 5x200 pcs - cut bag of 250 pcs - strips
PZ-2	~4.0 - 10.0 mm 2.5 to 10.0 mm ²	4 mm	1	bag of 5x100 pcs - cut bag of 250 pcs - strips

* Size shown refers to BS6231 tri-rated cable

+ RELATED PRODUCTS



MD/MDH
PAGE 87



CAS
PAGE 86



PUJ/MD10
PAGE 89

+ APPLICATION

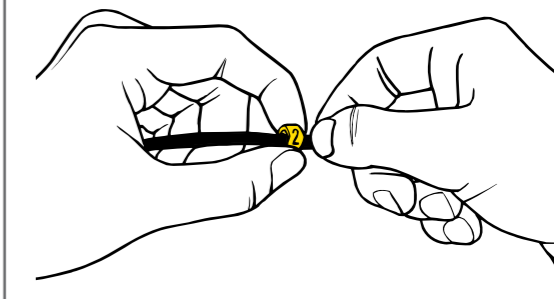



+ INFORMATION

- + Open markers for already connected wires
- + Securely positioned with help of barbs
- + Twist-protected for secure combination marking
- + Fast snap installation.

+ PROPERTIES

Temperature range
-30°C to +60°C

Material
PVC

Print
hot stamped

Standard colours
yellow and white
international colour code for 0-9

Text
0-9, A-Z, + - / : ~ ±



+ DIMENSIONS

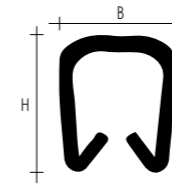

TYPE	HEIGHT (H mm)	WIDTH (B mm)	HEIGHT TEXT (mm)
PC-10	3.6	3.7	2.6
PC-20	4.2	4.5	2.6
PC-30	5.5	5.7	2.6
PC-40	6.5	6.9	4.0

+ SIZES AND PACKAGING

TYPE	CABLE DIAMETER	LENGTH	NUMBER OF CHARACTERS	PACKAGING
PC-10	~2.4 - 3.0 mm ~0.5 - 1.5 mm ²	3 mm	1	1000 piece multi pack
PC-20	~3.0 - 4.0 mm ~1.5 - 2.5 mm ²	3 mm	1	1000 piece multi pack
PC-30	~4.0 - 5.0 mm ~2.5 - 4.0 mm ²	3 mm	1	1000 piece multi pack
PC-40	~5.0 - 6.2 mm ~4.0 - 6.0 mm ²	4 mm	1	1000 piece multi pack

* Size shown refers to BS6231 tri-rated cable

+ APPLICATION

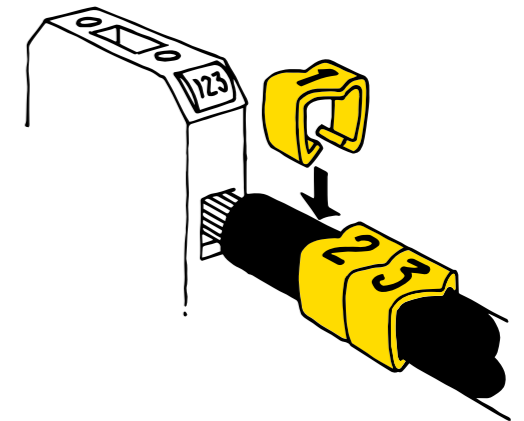



+ INFORMATION

- + Open markers for already connected wires
- + Designed to interlock when fitted enabling easy alignment of multi digit markings.
- + Two sizes cover all cable sizes from 0.5 to 4.0 mm².

+ PROPERTIES

Temperature range
-30°C to +100°C

Material
Halogen-free Polyamide 6.6

Print
hot stamped

Standard colours
black on white, or black on yellow
international colour codes 0-9

Text
0-9, A-Z, + - / : ~ ±, or blank

Properties
Excellent resistance to petrol, oils and fats.

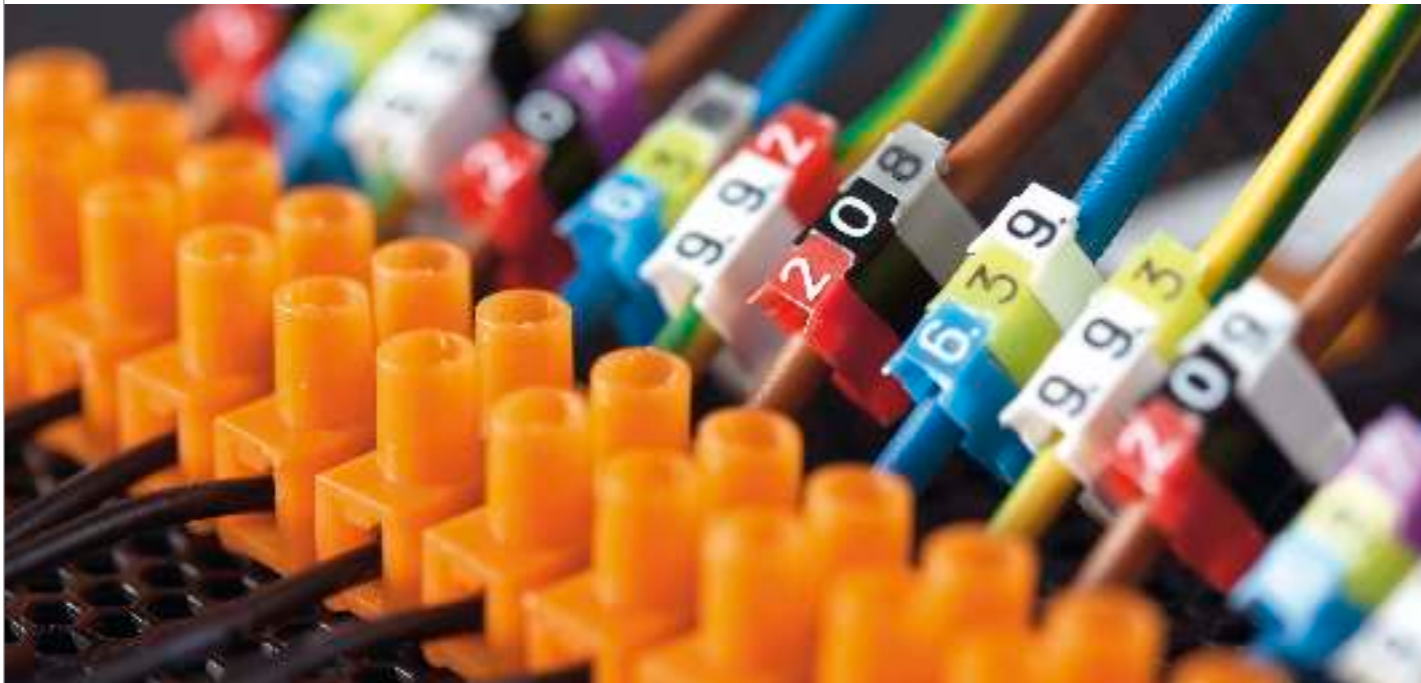

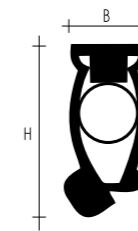

+ DIMENSIONS



TYPE	HEIGHT (H mm)	WIDTH (B mm)	HEIGHT TEXT (mm)
PCA1	9.5	5.0	3.0
PCA2	13.0	5.0	3.0

+ SIZES AND PACKAGING

TYPE	DIAMETER / CABLE SIZE*	LENGTH	NUMBER OF CHARACTERS	PACKAGING
PCA1	2.2 - 3.6 mm 0.5, 0.75, 1.0, or 1.5 mm ²	4 mm	1	 pack of 320 pcs (10 strips of 32 markers)
PCA2	3.6 - 6.0 mm 2.5 or 4.0 mm ²	4 mm	1	 pack of 320 pcs (10 strips of 32 markers)

* Size shown refers to BS6231 tri-rated cable

+ APPLICATION

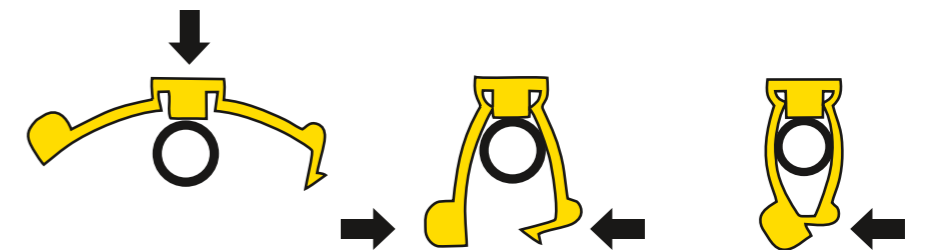



+ INFORMATION

- + Combination marker for cable and pipe marking
- + One size for all diameters
- + Installed quickly onto Partex PKH or POH holder which is fastened with cable ties around the cable
- + Entirely closed and twist-protected
- + Highly durable in exposed environments and with excellent readability

+ PROPERTIES

Temperature range

PK+: -30°C to +60°C
PKZ: -30°C to +90°C

Material

PK+: PVC
PKZ: ZEREX

Print

PK+: hot stamped, PKZ: ink

Standard colours

yellow and white and the international colour code for 0-9

Text

0-9, A-Z, +, -, /, ~, ↓

+ APPLICATION

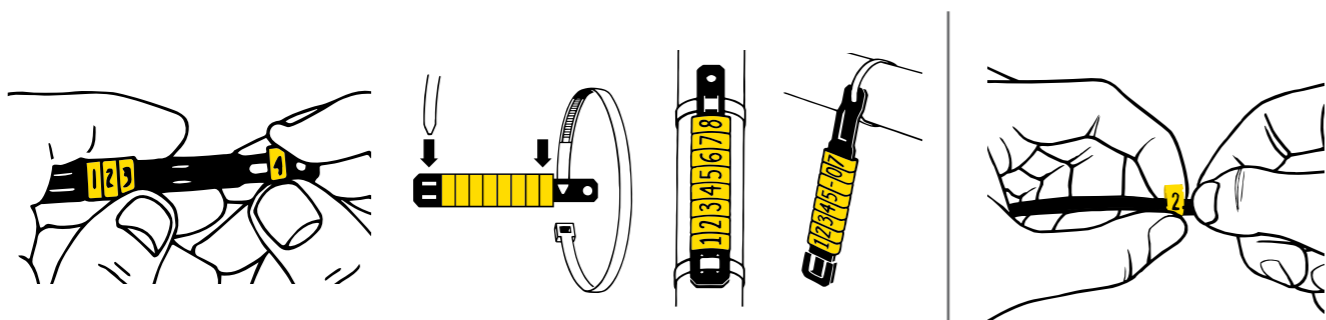

+ RELATED PRODUCTS



HFC
PAGE 95



POH



PKH

+ DIMENSIONS

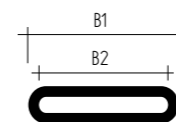

TYPE	WIDTH (B1 mm)	WIDTH (B2 mm)	HEIGHT TEXT (mm)
PK+/PKZ2	11.3	10.0	4.0

+ ACCESSORIES

PRODUCT	LENGTH	MAX. QUANTITY PK-2	MAX. QUANTITY PKZ2	PACKAGING
PKH070	70 mm	10	-	pack of 100 pcs
PKH070POL	70 mm	10	7	pack of 100 pcs
PKH100POL	100 mm	20	13	pack of 100 pcs
POH07	60 mm	8	-	pack of 100 pcs
POH12	82 mm	13	-	pack of 100 pcs
POH18	110 mm	19	-	pack of 100 pcs
POH30	150 mm	30	-	pack of 100 pcs

PKH are available in black only, POH are available in black, white and yellow (other colours on request)

+ SIZES AND PACKAGING

TYPE	LENGTH	NUMBER OF CHARACTERS	PACKAGING
PK+/PKZ2	4 mm	1	pack of 5x100 pcs - cut
PK+/PKZ2	4 mm	1	compact disc 500 pcs

